

JRCZ DETAILS

JOINT RESEARCH CENTER ZEELAND



detailnummer	schaal	Status	Datum
40 - details			
U40-00		U0	17-12-2020
U40-001		U0	17-12-2020
U40-004		U0	17-12-2020
U40-A1	1:10	U0	17-12-2020
U40-A2	1:10	U0	17-12-2020
U40-A3	1:10	U0	17-12-2020
U40-A4	1:10	U0	17-12-2020
U40-A5	1:10	U0	17-12-2020
U40-A6	1:10	U0	17-12-2020
U40-B1	1:10	U0	17-12-2020
U40-B2	1:10	U0	17-12-2020
U40-B3	1:10	U0	17-12-2020
U40-B4	1:10	U0	17-12-2020
U40-B5	1:10	U0	17-12-2020
U40-C1	1:10	U0	17-12-2020
U40-C2	1:10	U0	17-12-2020
U40-C3	1:10	U0	17-12-2020
U40-D1	1:10	U0	17-12-2020
U40-D2	1:10	U0	17-12-2020
U40-D3	1:10	U0	17-12-2020
U40-D4	1:10	U0	17-12-2020
U40-D5	1:10	U0	17-12-2020
U40-E1	1:10	U0	17-12-2020
U40-E2	1:10	U0	17-12-2020
U40-E3	1:10	U0	17-12-2020
U40-E4	1:10	U0	17-12-2020
U40-F3	1:10	U0	17-12-2020
U40-F4	1:10	U0	17-12-2020
U40-F5	1:10	U0	17-12-2020
U40-G1	1:10	U0	17-12-2020
U40-G2	1:10	U0	17-12-2020
U40-G3	1:10	U0	17-12-2020
U40-G4	1:10	U0	17-12-2020
U40-G5	1:10	U0	17-12-2020
U40-G6	1:10	U0	17-12-2020
U40-H1	1:10	U0	17-12-2020
U40-H2	1:10	U0	17-12-2020
U40-H3	1:10	U0	17-12-2020
U40-J1	1:10	U0	17-12-2020
U40-J2	1:10	U0	17-12-2020
U40-J3	1:10	U0	17-12-2020
U40-J4	1:10	U0	17-12-2020
U40-K1	1:10	U0	17-12-2020
U40-K2	1:10	U0	17-12-2020
U40-L1	1:10	U0	17-12-2020
U40-N1	1:10	U0	17-12-2020
U40-P1	1:10	U0	17-12-2020
U40-R1	1:10	U0	17-12-2020
U40-R2	1:10	U0	17-12-2020
U40-R3	1:10	U0	17-12-2020
U40-R4	1:10	U0	17-12-2020
U40-R5	1:10	U0	17-12-2020

ROTHUIZEN

ARCHITECTEN STEDENBOUWKUNDIGEN



BOUWMEESTERPRO

project: **JRCZ Middelburg** datum: 17-12-2020 formaat: A3 getekend: hdc/ mte status: U0
onderdeel: **Voorblad details** schaal: infoniveau: 300 projectnr: PR19-03 document: U40-00
contact: www.rothuizen.eu

Detail overzicht 00 begane-grond

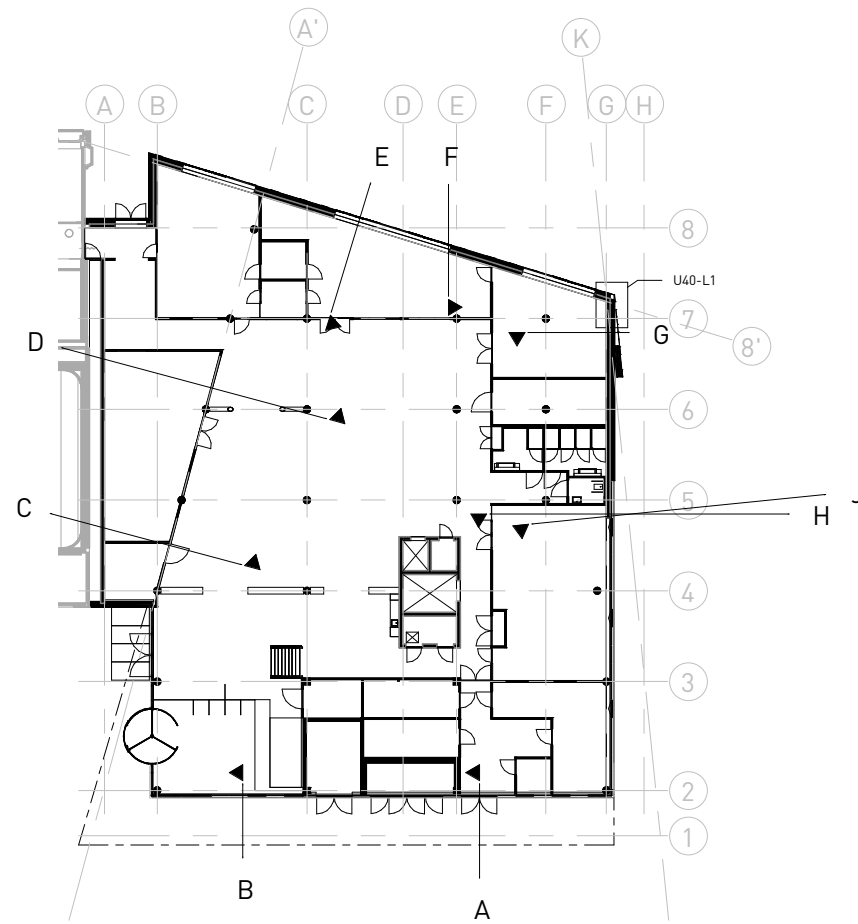

Detail overzichten 04 verdieping

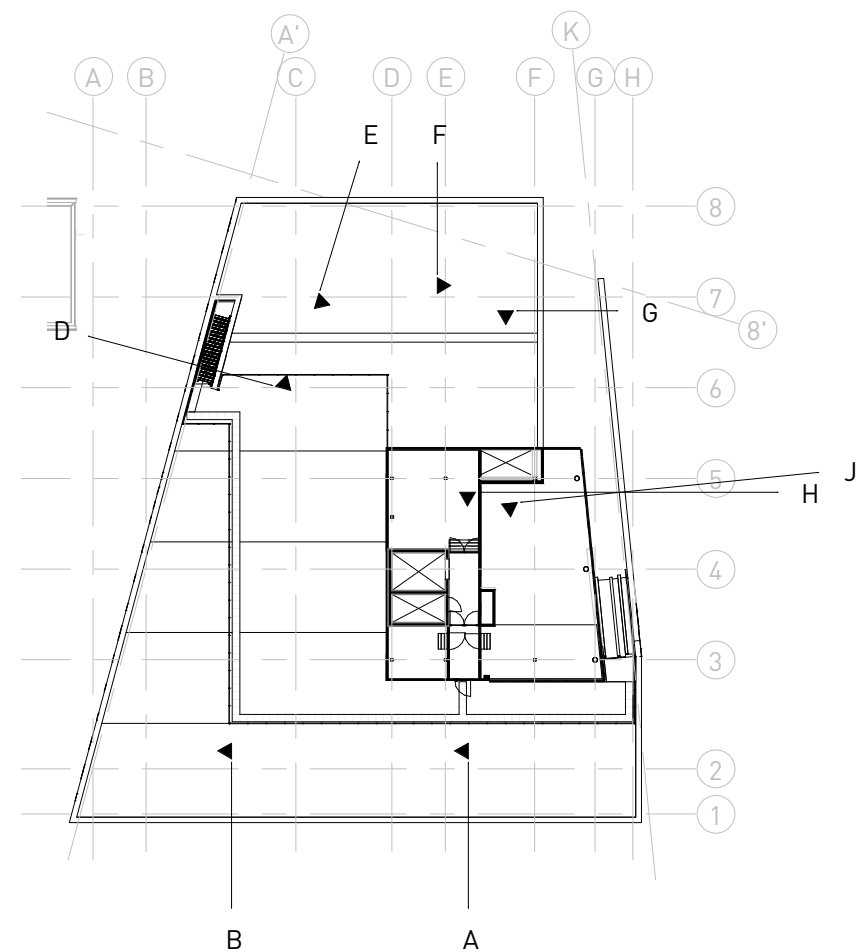

Detail overzicht 01 verdieping

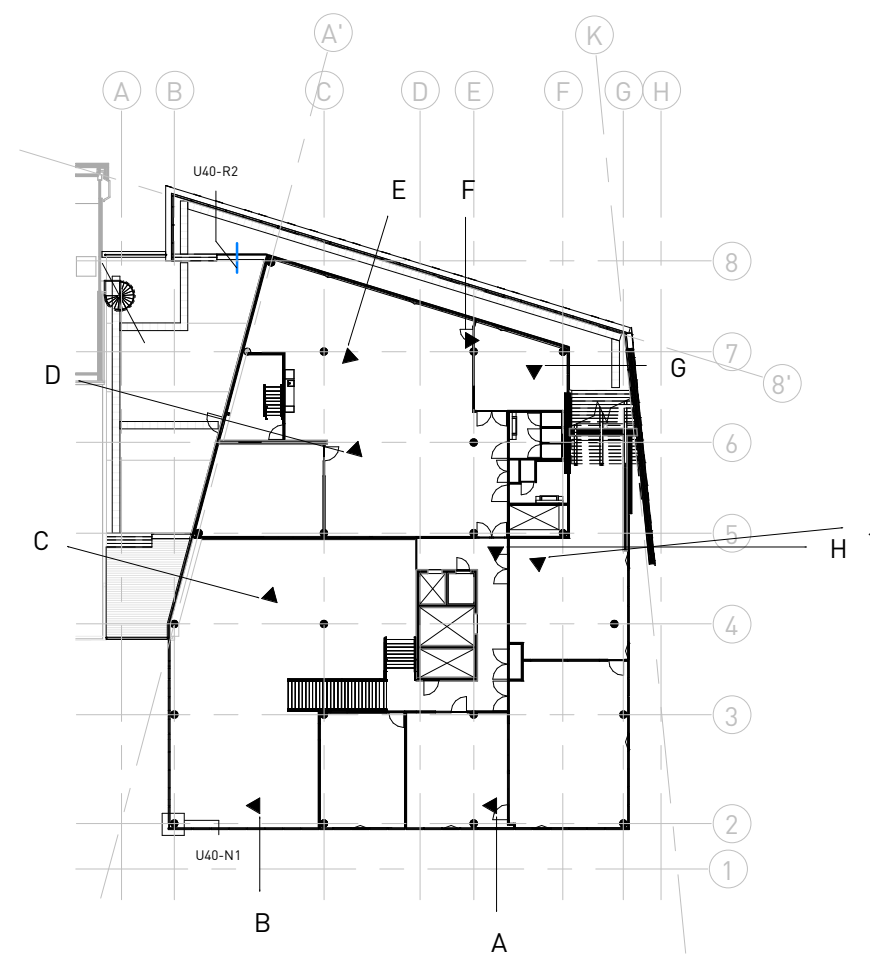

Detail overzichten 05 dak

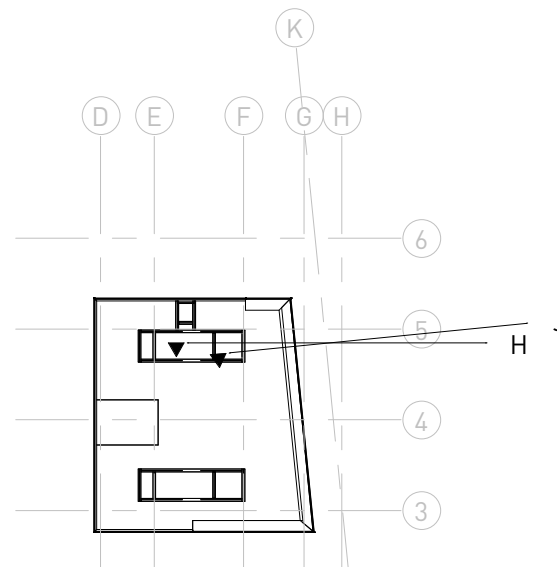

Detail overzicht 03 verdieping

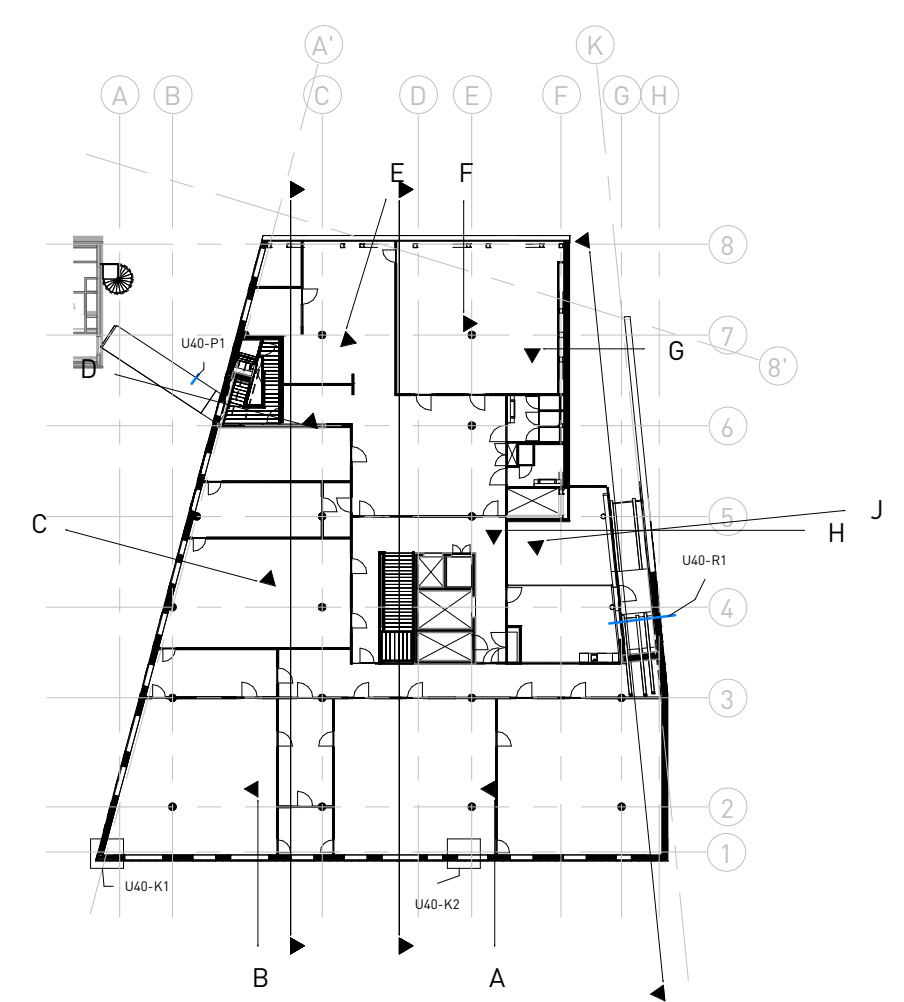

ROTHUIZEN
ARCHITECTEN STEDENBOUWKUNDIGEN

BOUWMEESTERPRO

project: JRCZ Middelburg datum: 17-12-2020 formaat: A3 getekend: mte status: UO
 onderdeel: Detailoverzichten plgr. schaal: 1 : 500 infoniveau: projectnr: PR19-03 document: U40-001
 contact: www.rothuizen.eu

Detailsnede_A overzicht

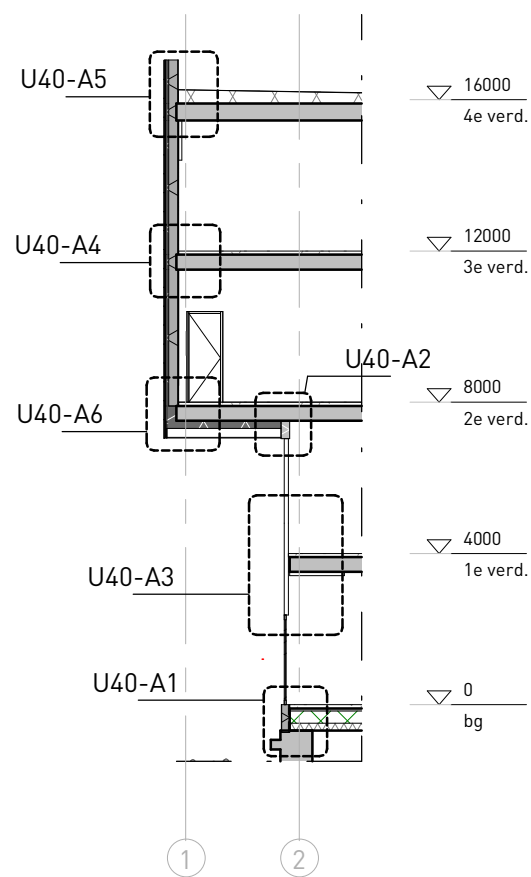

Detailsnede_B overzicht

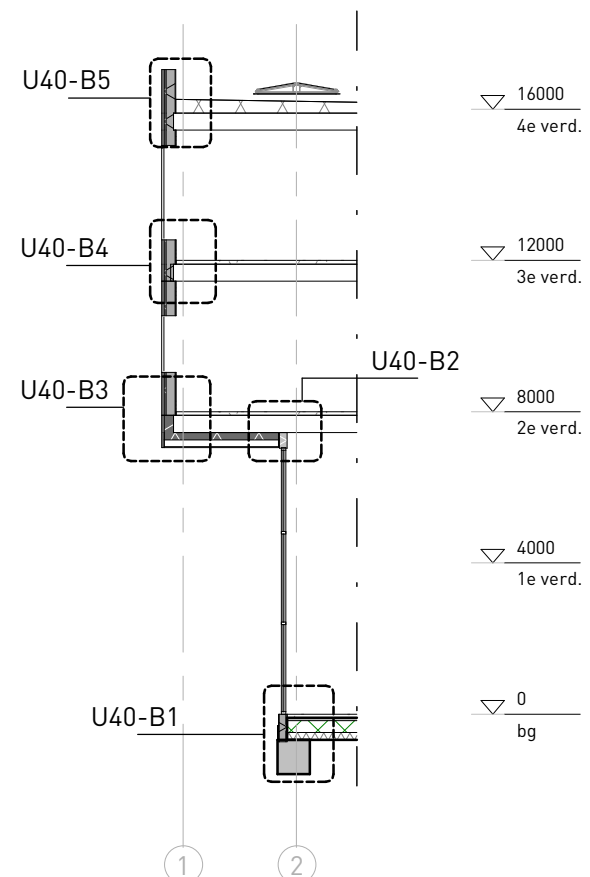

Detailsnede_C overzicht

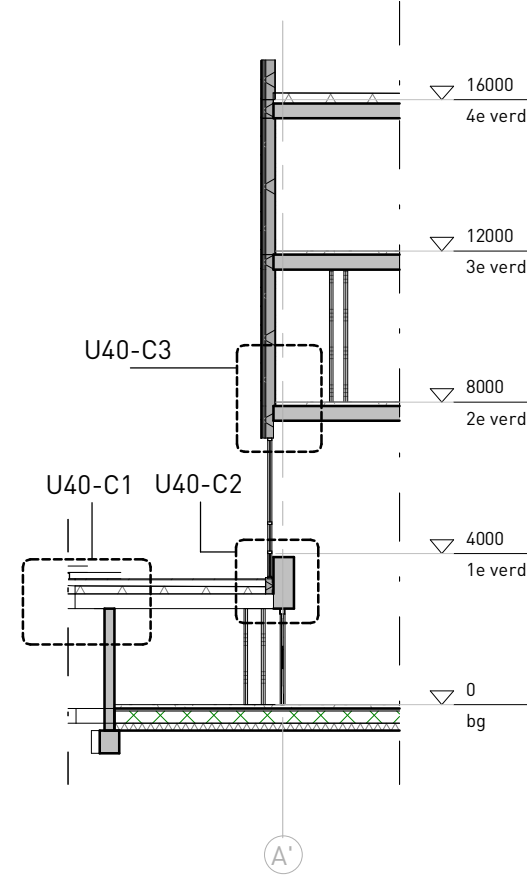

Detailsnede_D overzicht

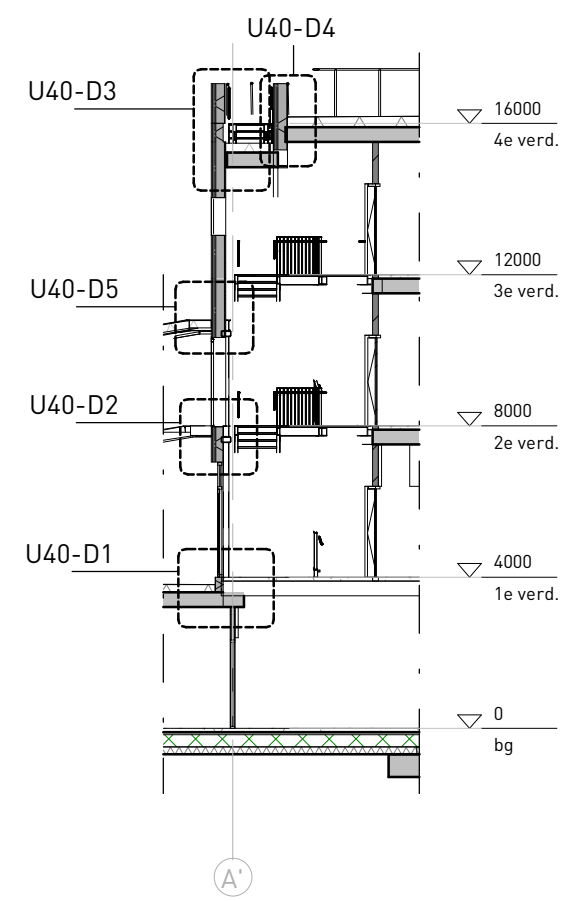

Detailsnede_E overzicht

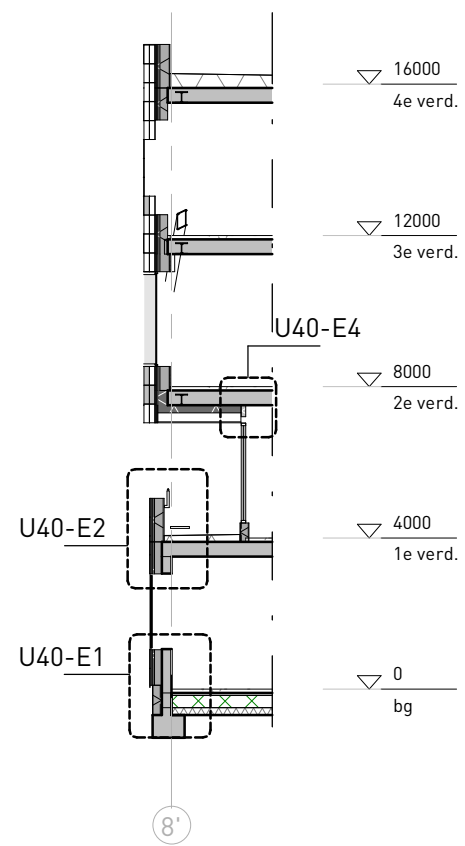

Detailsnede_F overzicht

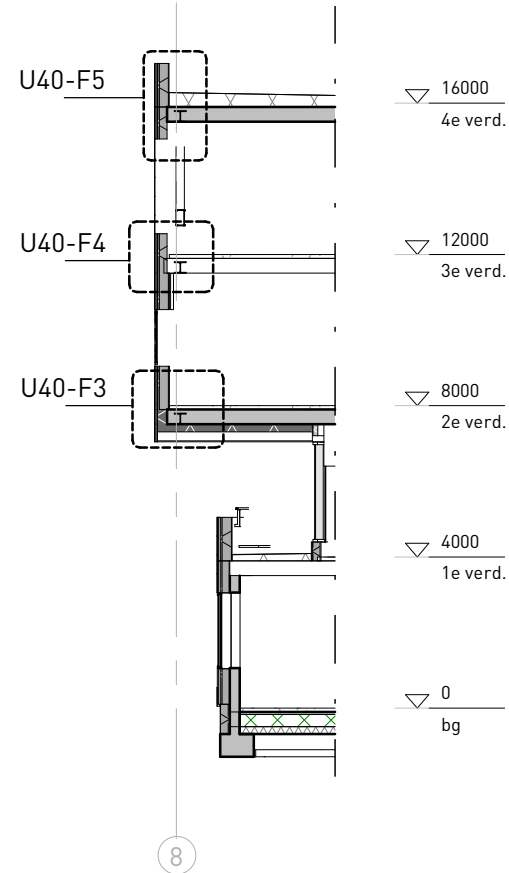

Detailsnede_G overzicht

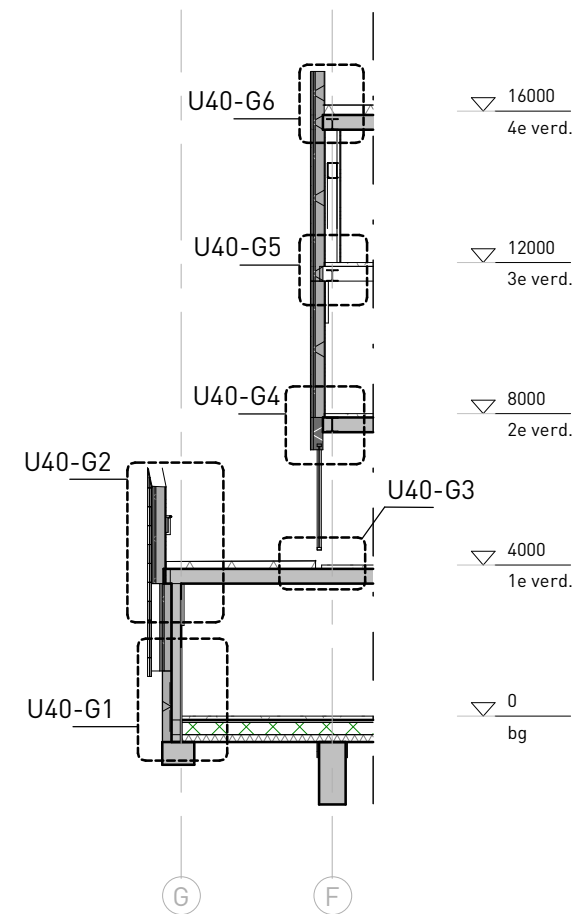

Detailsnede_H overzicht

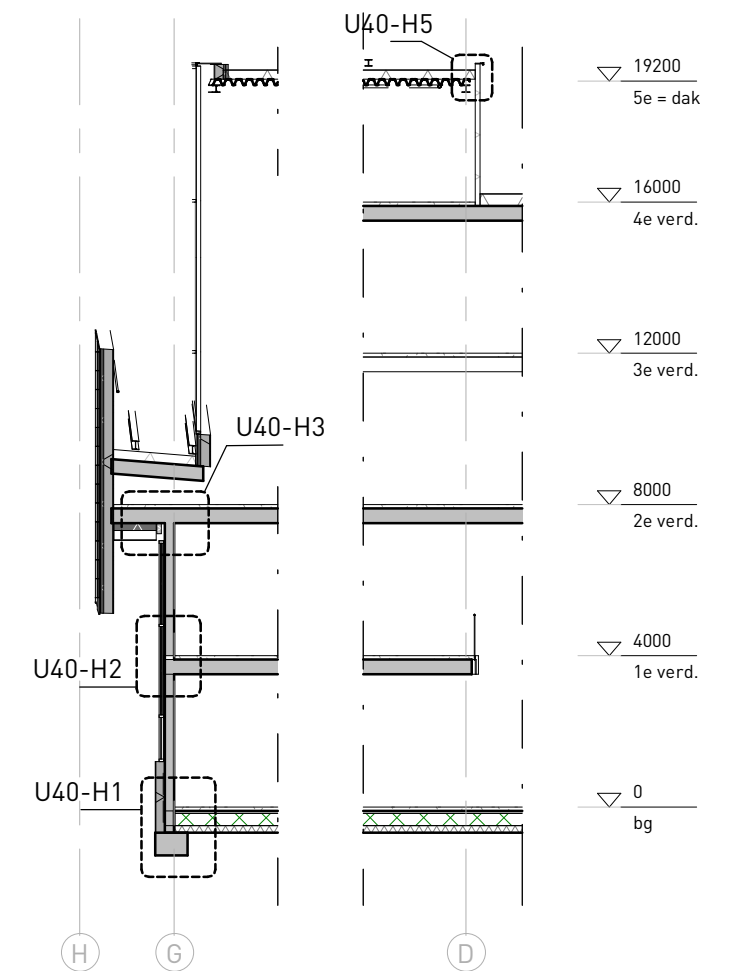

Detailsnede_J overzicht

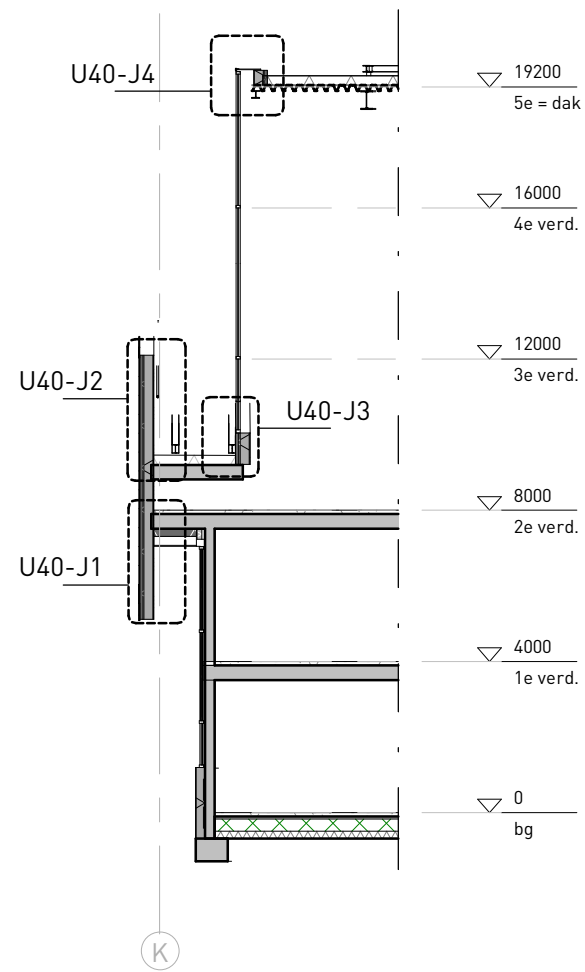

Detailsnede_R overzicht

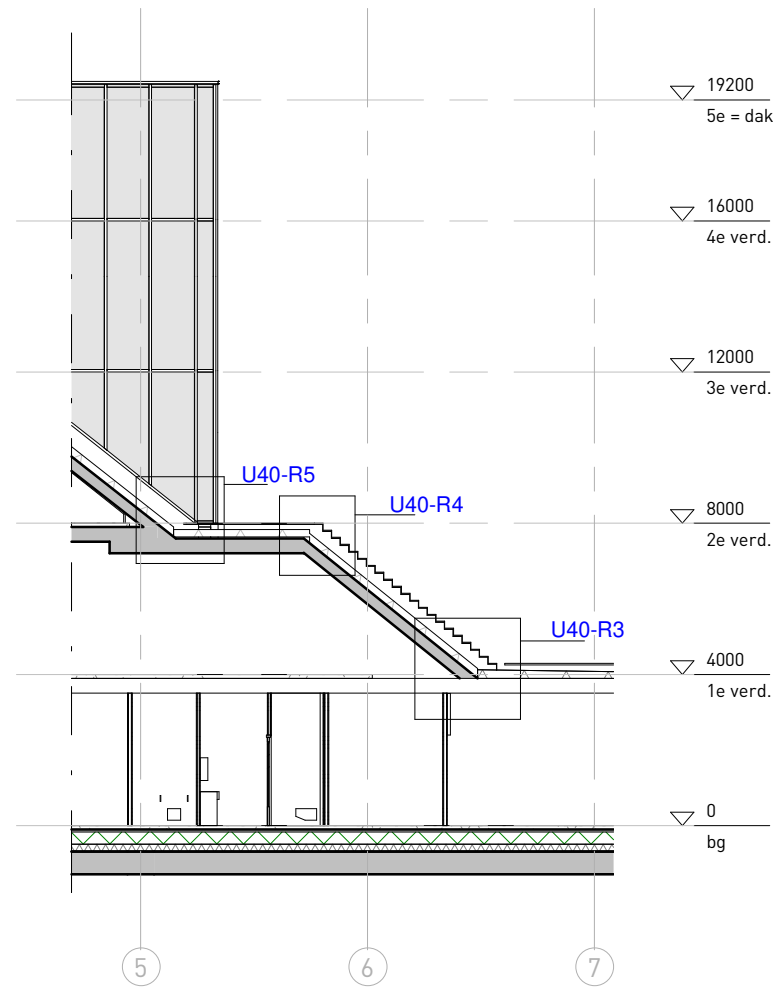

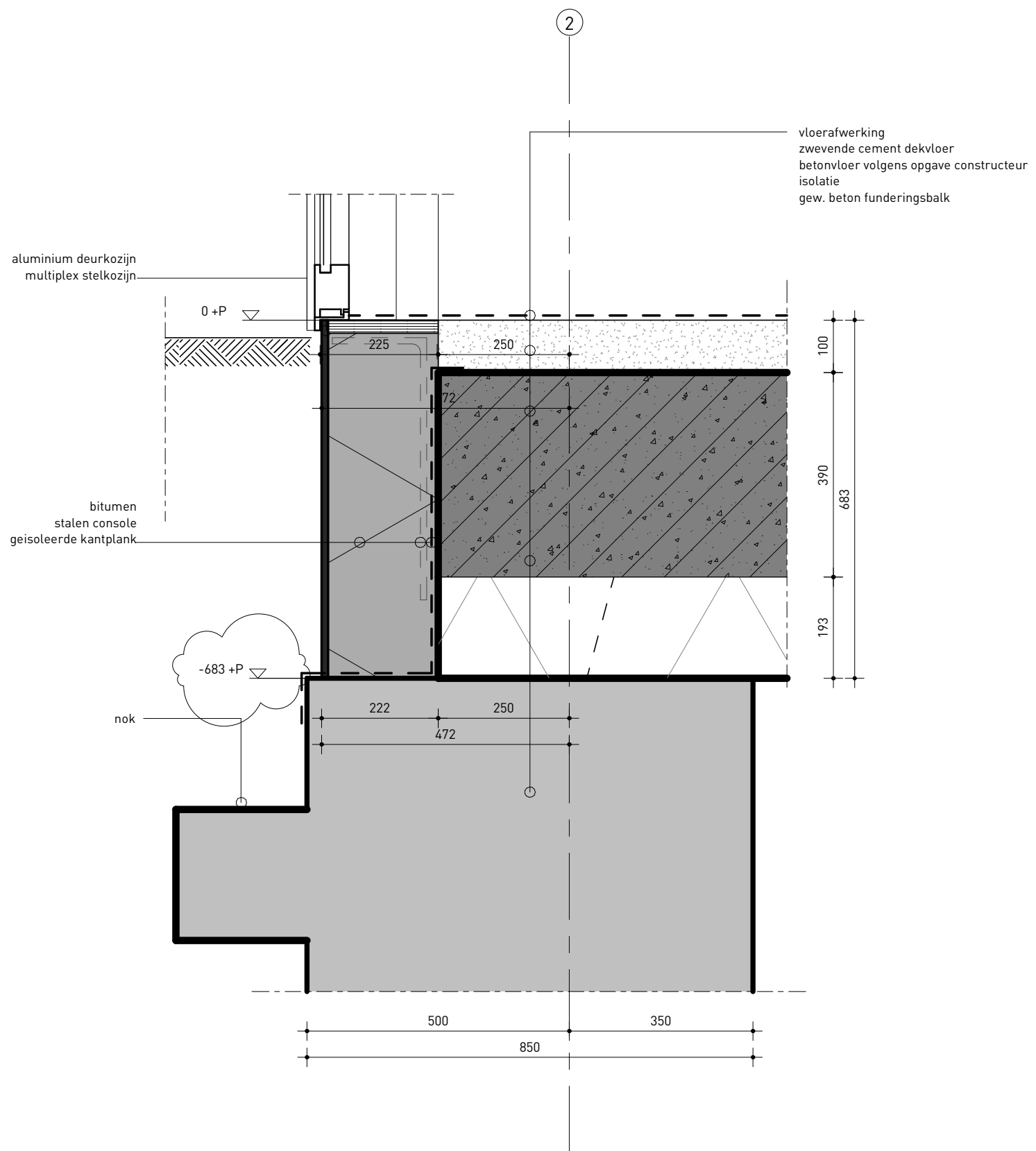

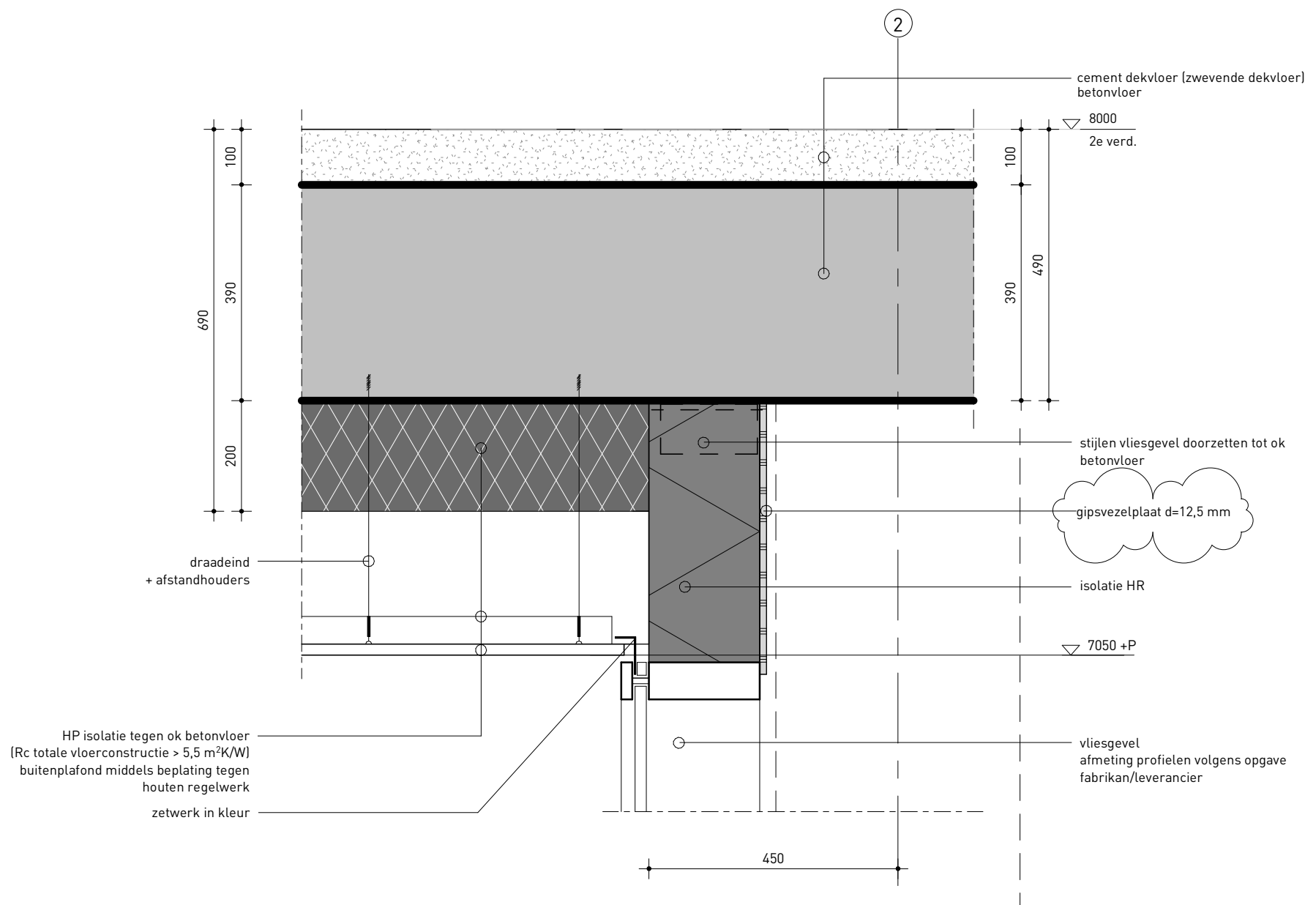

2

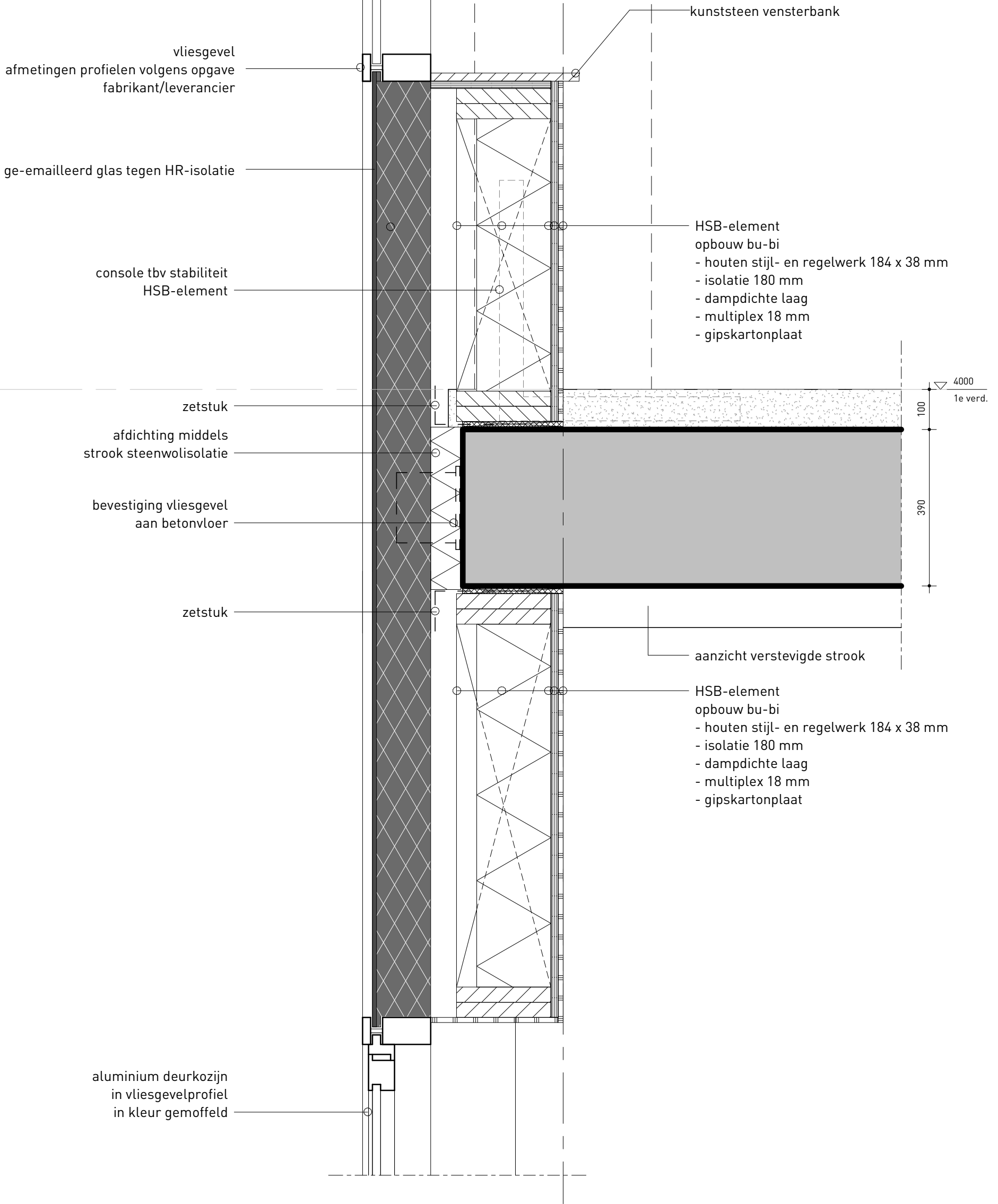

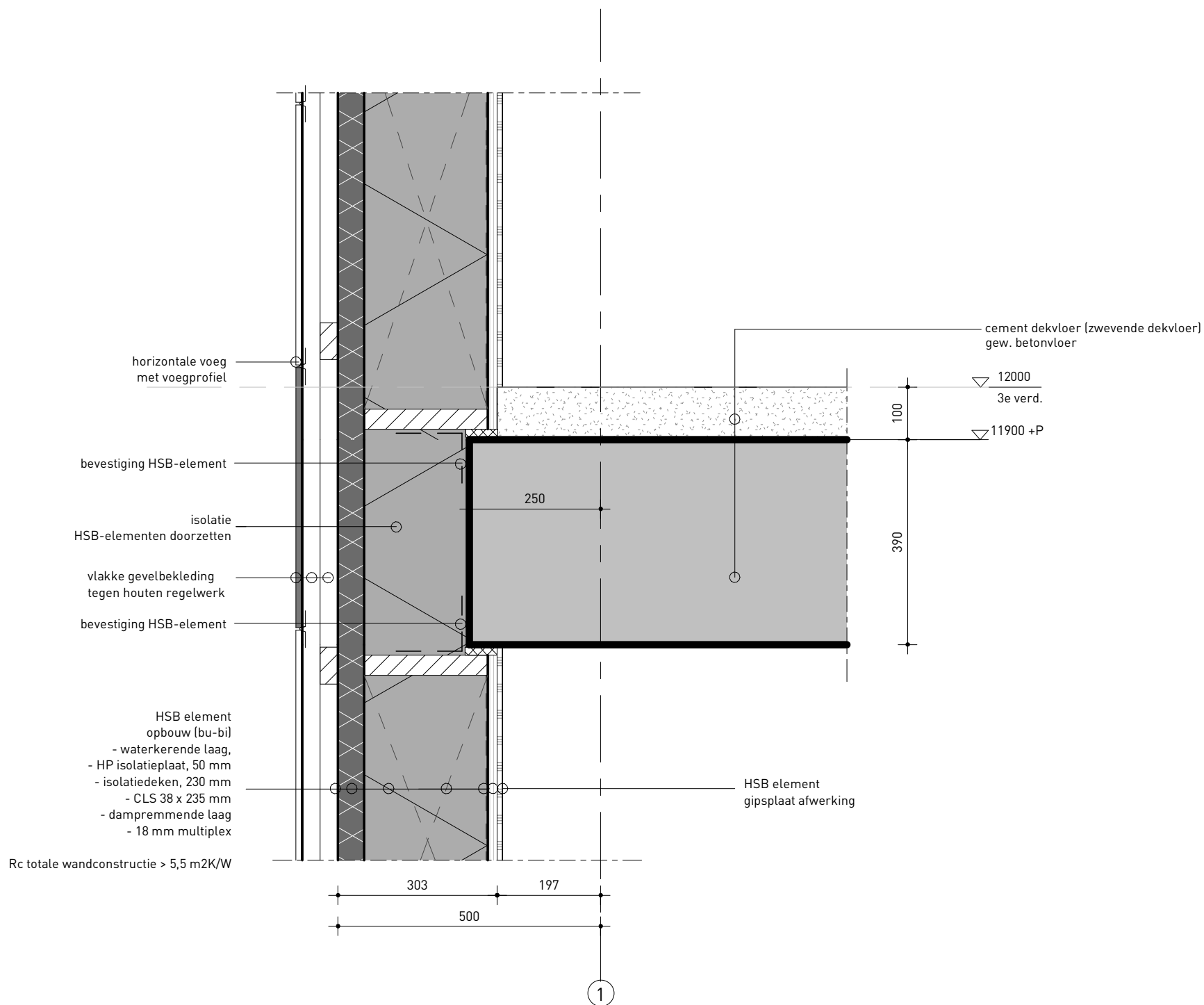

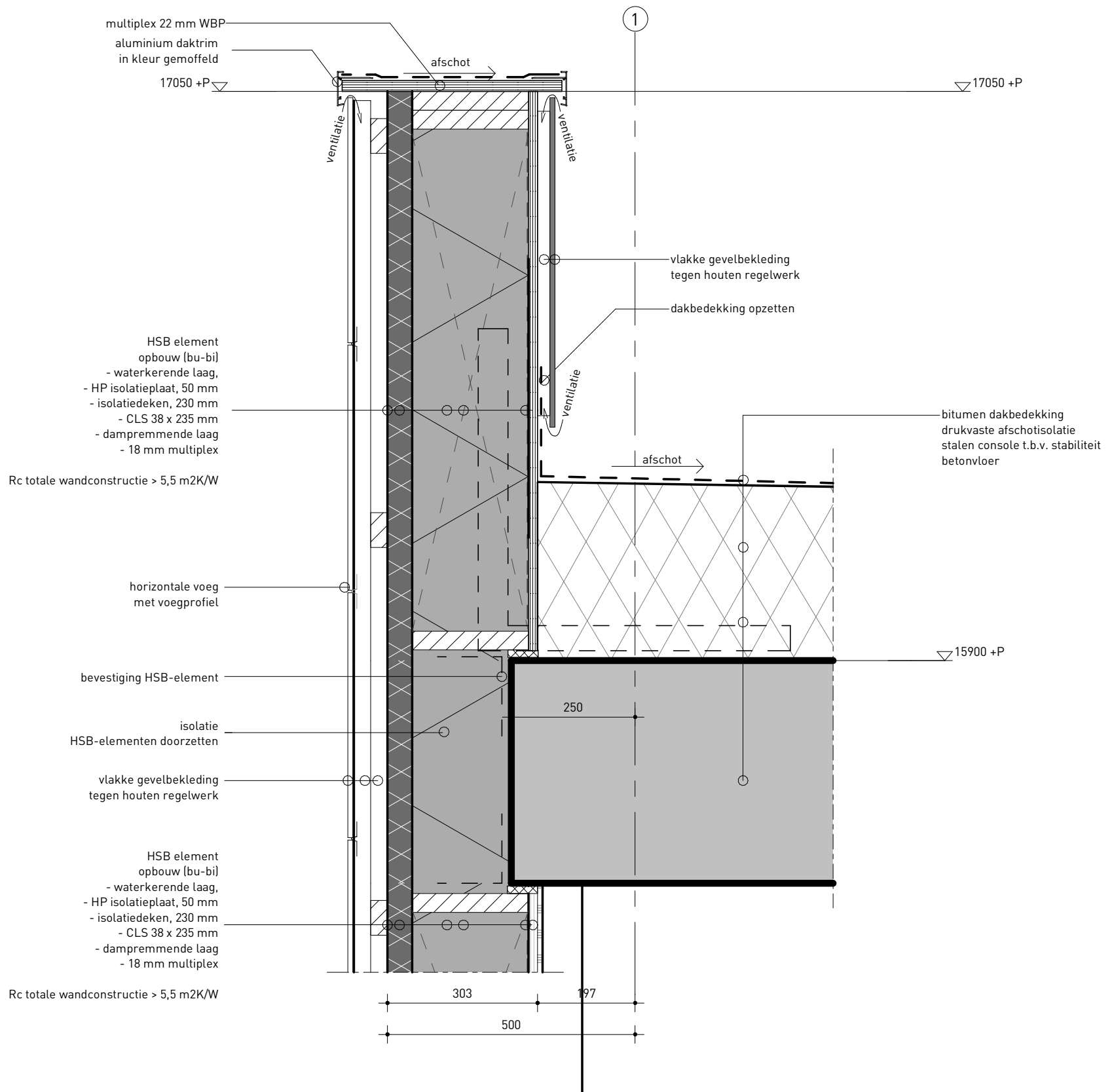

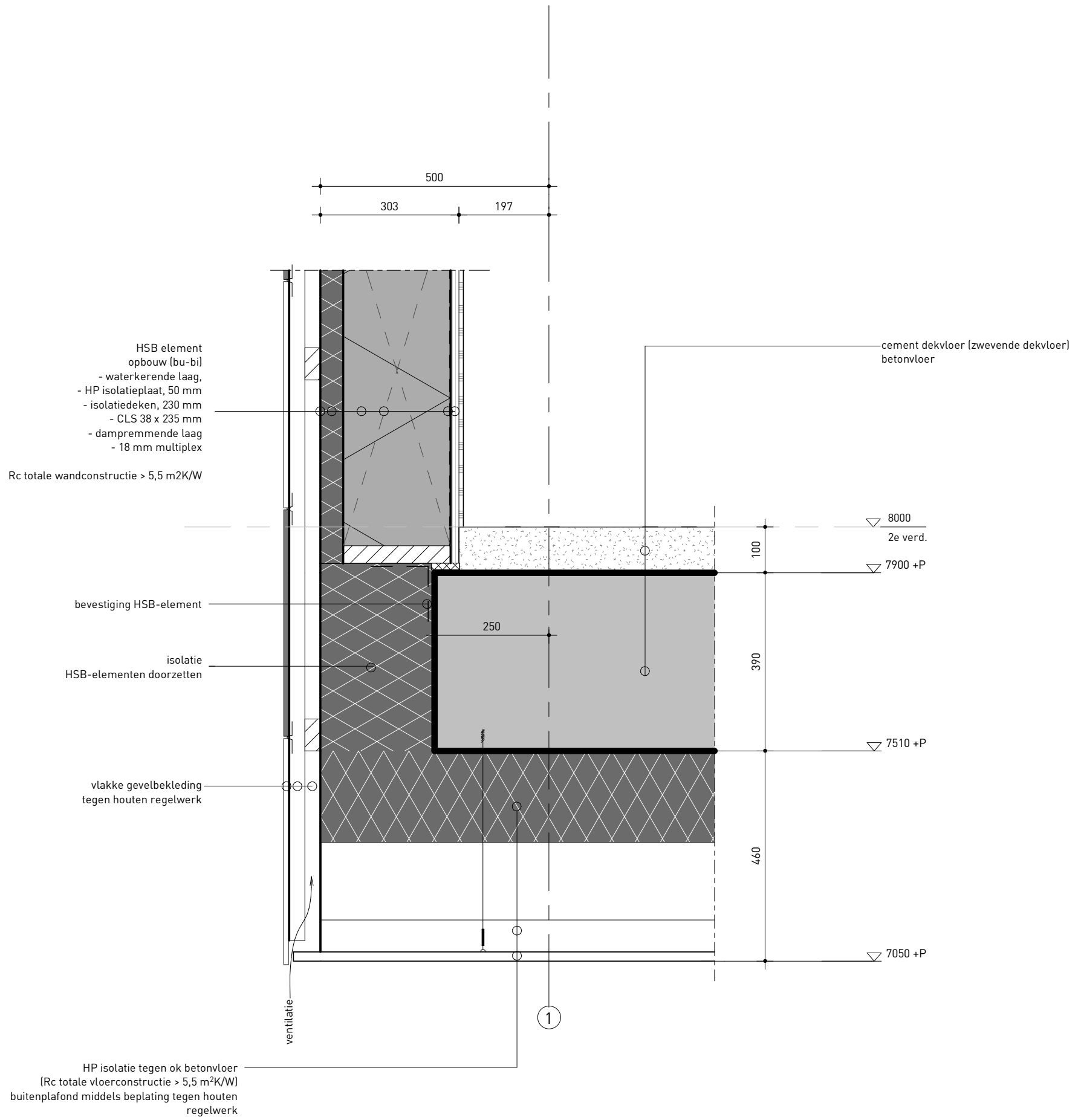

ROTHUIZEN

ARCHITECTEN STEDENBOUWKUNDIGEN



BOUWMEESTERPRO

project: JRCZ Middelburg datum: 17-12-2020 formaat: A3p getekend: HDC status: U0
 onderdeel: Principedetail A6 schaal: 1:10 infoniveau: 300 projectnr: PR19-03 document: U40-A6
 contact: www.rothuizen.eu

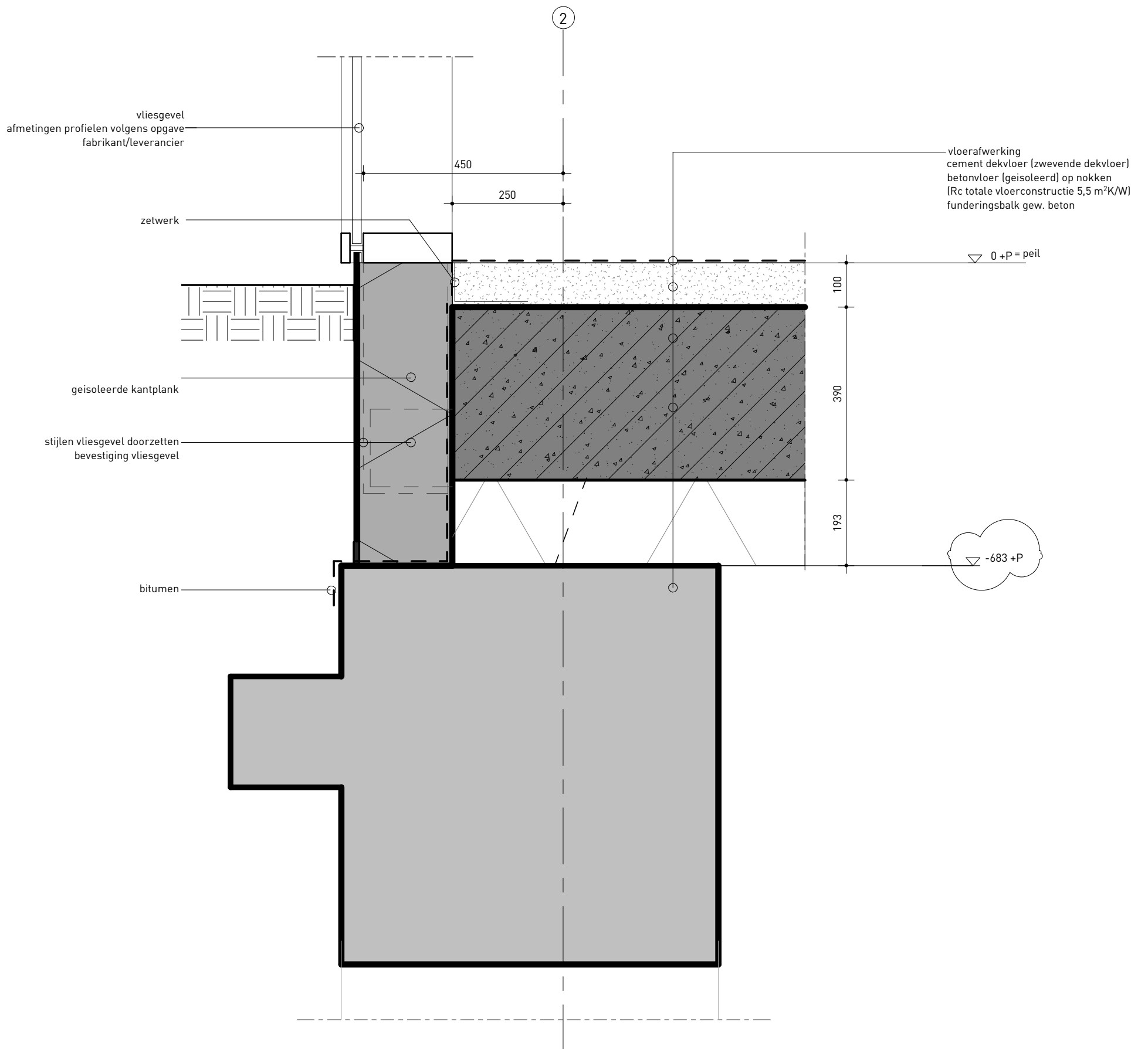

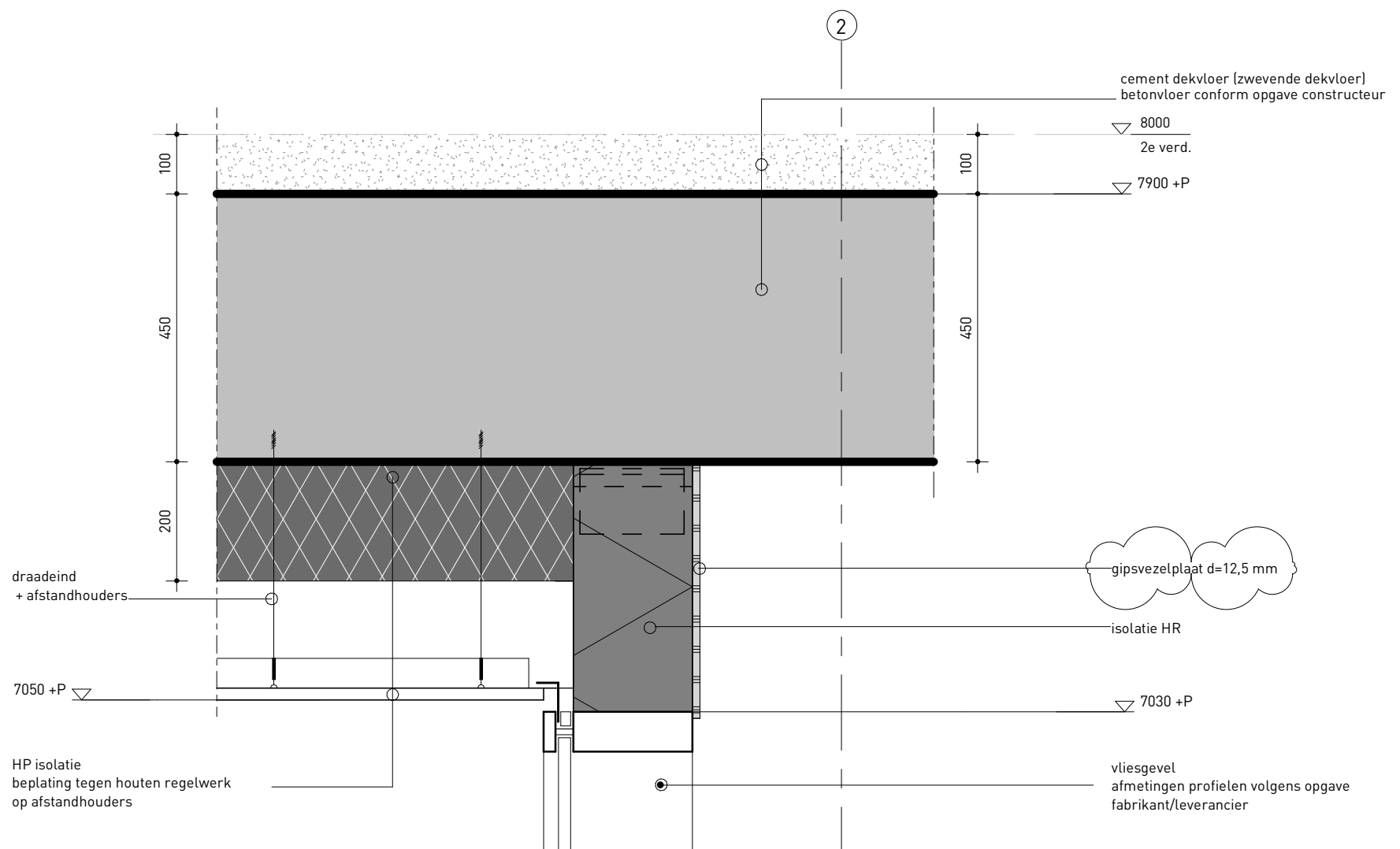

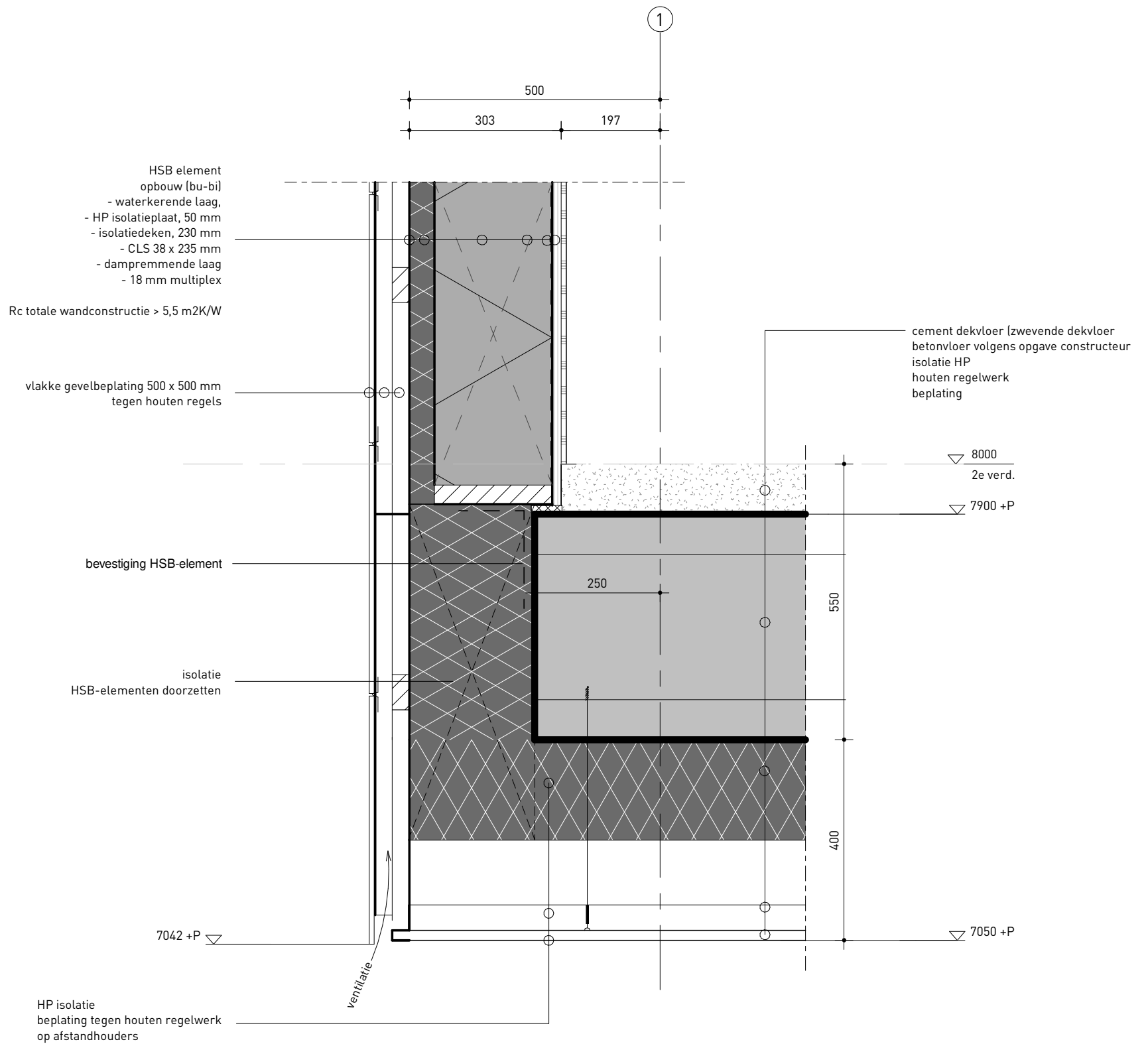

ROTHUIZEN

ARCHITECTEN STEDENBOUWKUNDIGEN



BOUWMEESTERPRO

project: JRCZ Middelburg	datum: 17-12-2020	formaat: A3p	getekend: HDC	status: U0
onderdeel: Principedetail B3	schaal: 1 : 10	infoniveau: 300	projectnr: PR19-03	document: U40-B3
contact: www.rothuisen.eu				

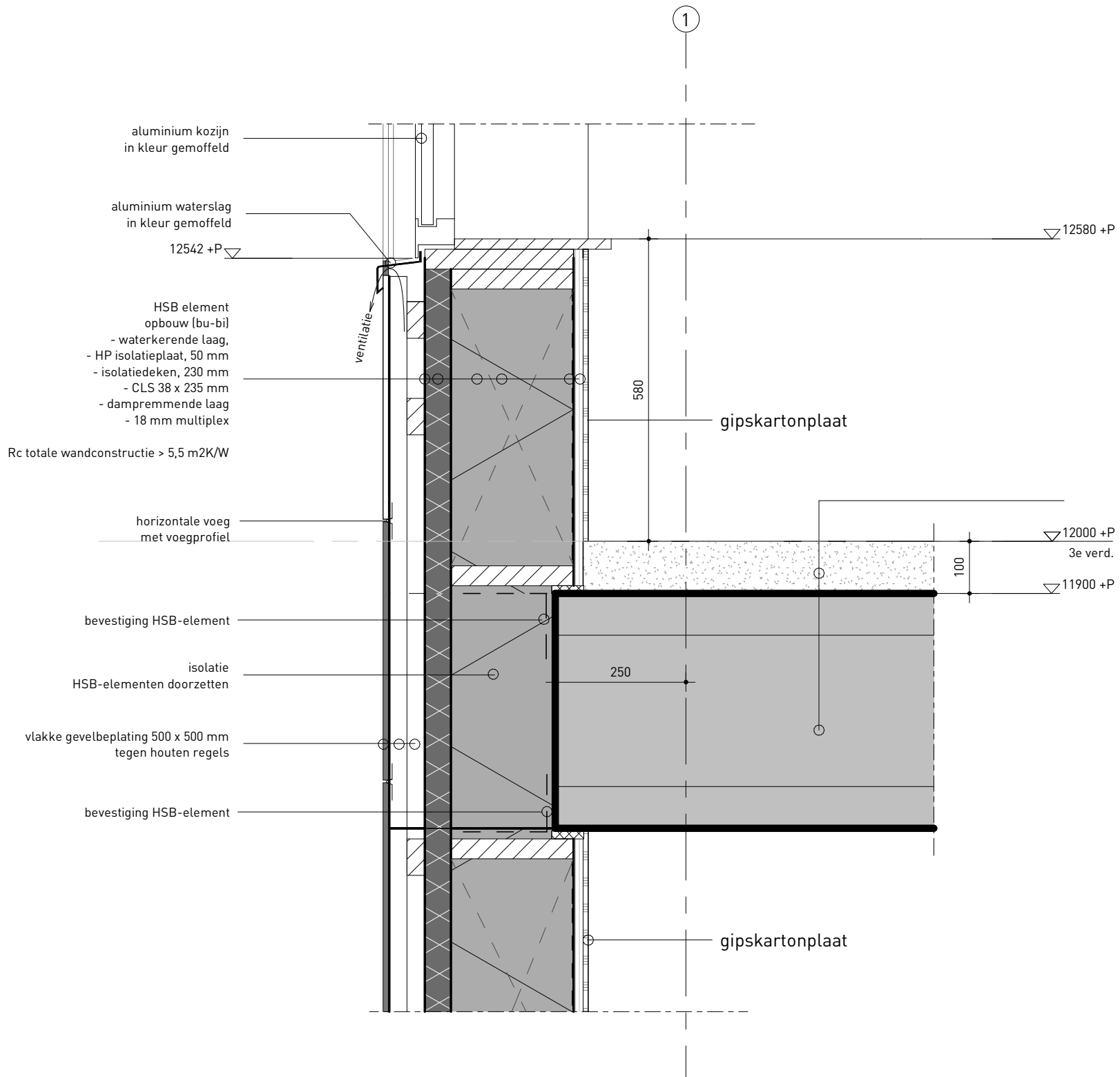

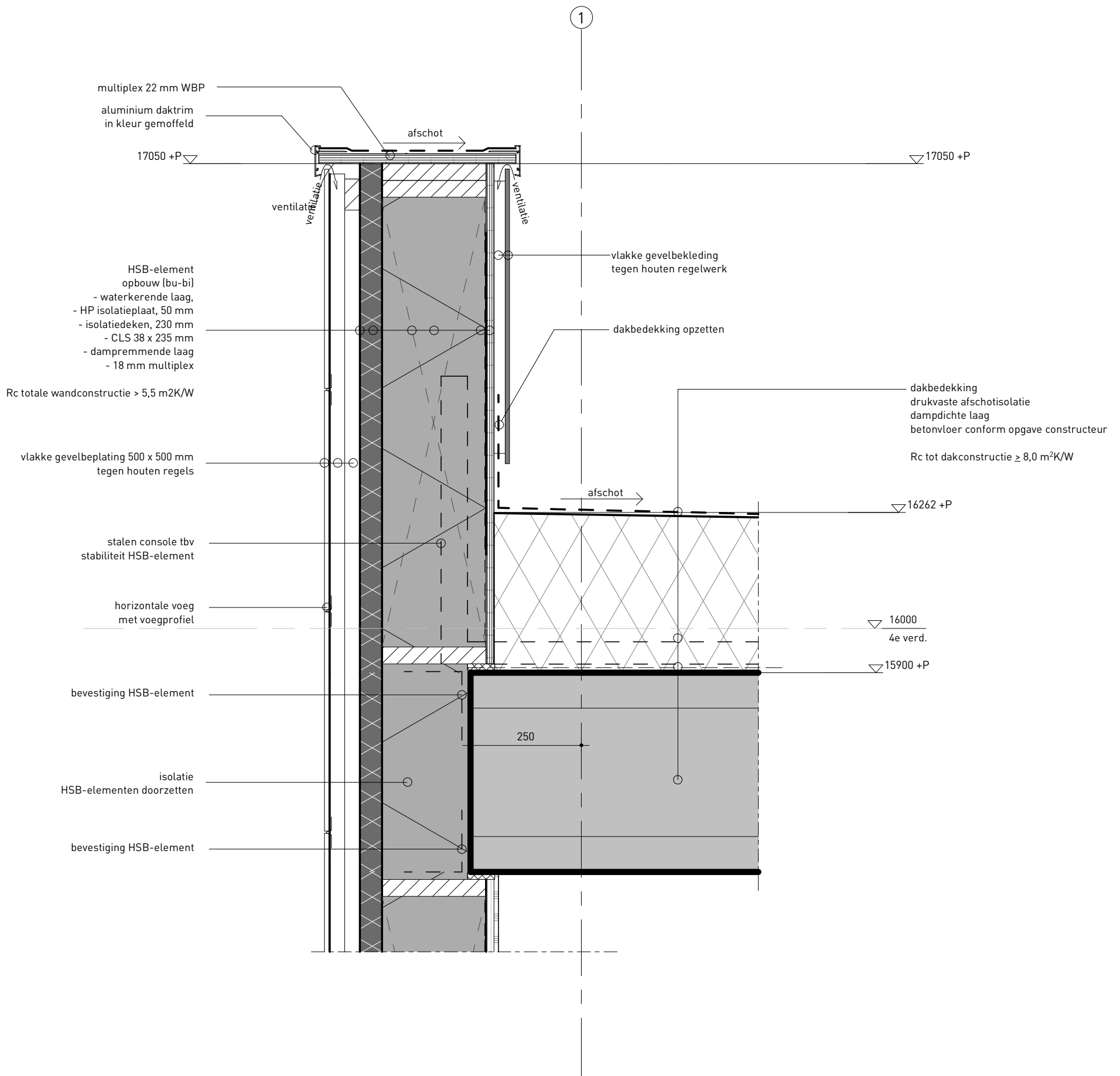

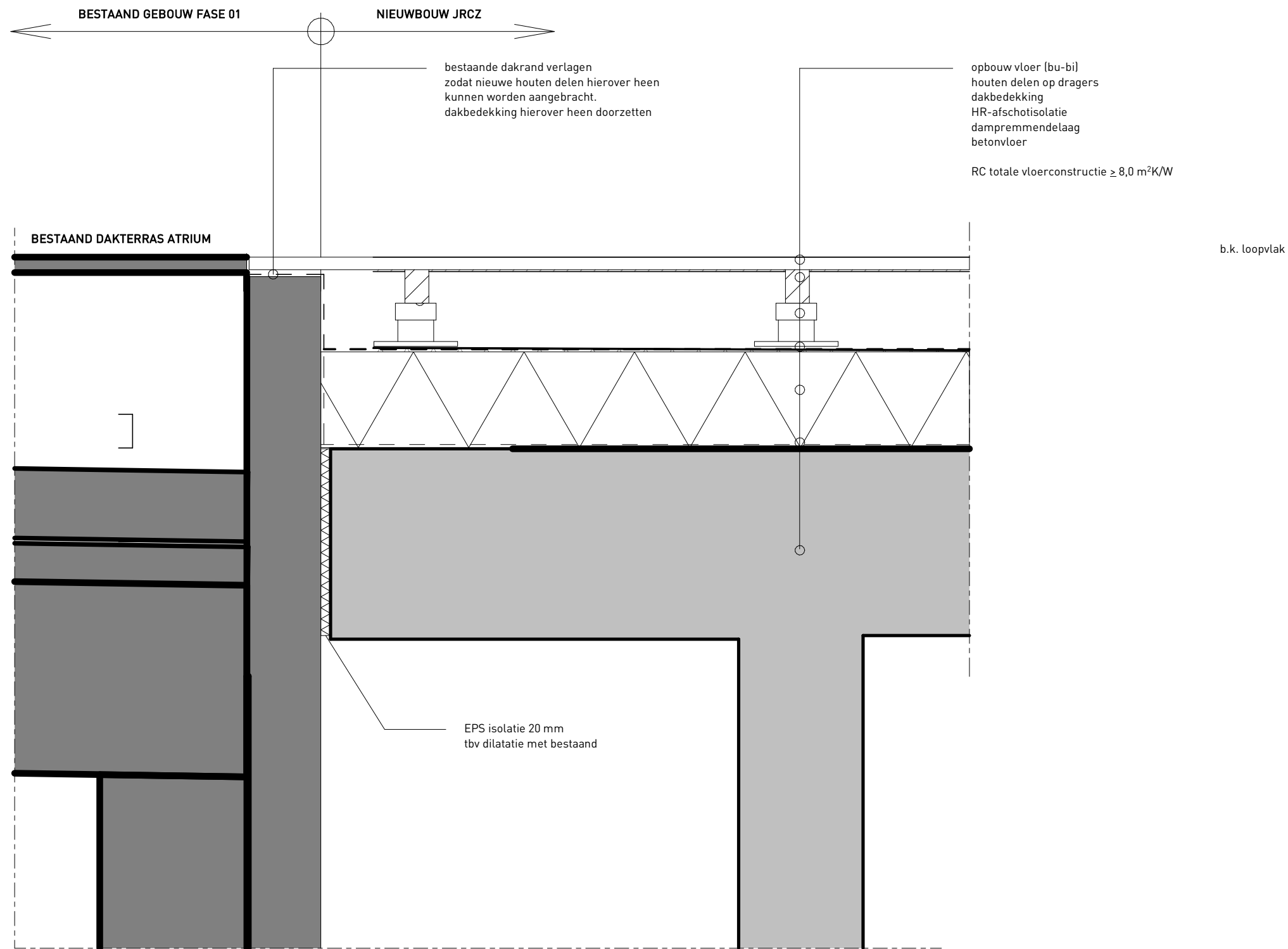

1e verd.
000 +P

A'

vliesgevel
afmetingen profielen volgens opgave
fabrikant/leverancier

kunststeen vensterbank

▽ 4000

1e verd. / o.k. kozijn

aluminium sandwichpaneel
in kleur gemoffeld

100

bevestiging vliesgevel
conform opgave fabrikant

betonconstructie
conform opgave constructeur

▽ 3330 +P

dakbedekking opzetten
opbouw vloer (bu-bi)
houten delen op dragers
dakbedekking
HR-afschotisolatie
dampremmendelaag
betonvloer

RC totale vloerconstructie $\geq 8.0 \text{ m}^2\text{K/W}$

593



project: JRCZ Middelburg	datum: 17-12-2020	formaat: A3p	getekend: HDC	status: U0
onderdeel: Principedetail C2	schaal: 1:10	infoniveau: 300	projectnr: PR19-03	document: U40-C2
contact: www.rothuizen.eu				

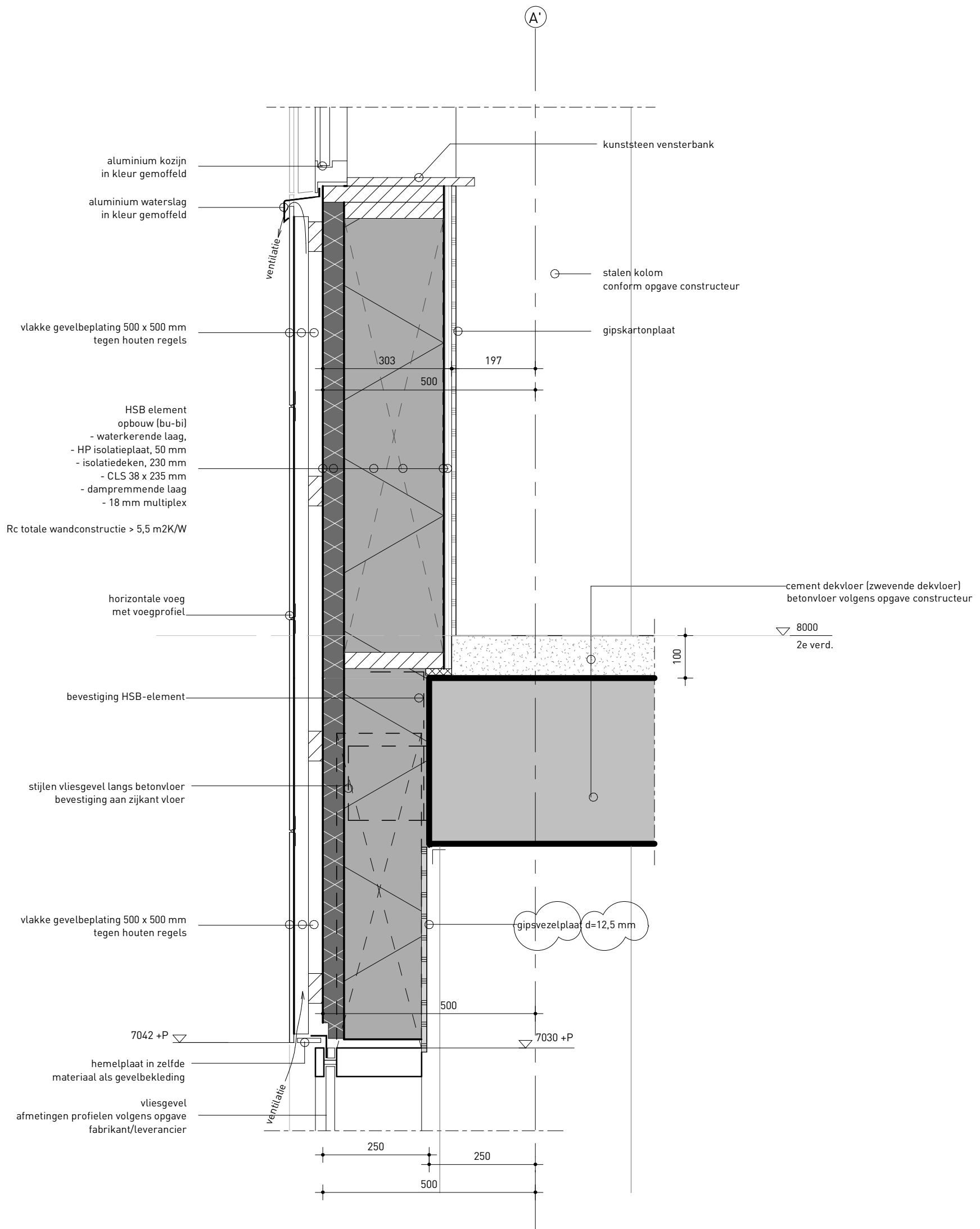

ROTHUIZEN

ARCHITECTEN STEDENBOUWKUNDIGEN



BOUWMEESTERPRO

project: **JRCZ Middelburg** datum: 17-12-2020 formaat: A3p getekend: HDC status: UO

onderdeel: **Principedetail C3** schaal: 1:10 infoniveau: 300 projectnr: PR19-03 document: U40-C3

contact: www.rothuizen.eu

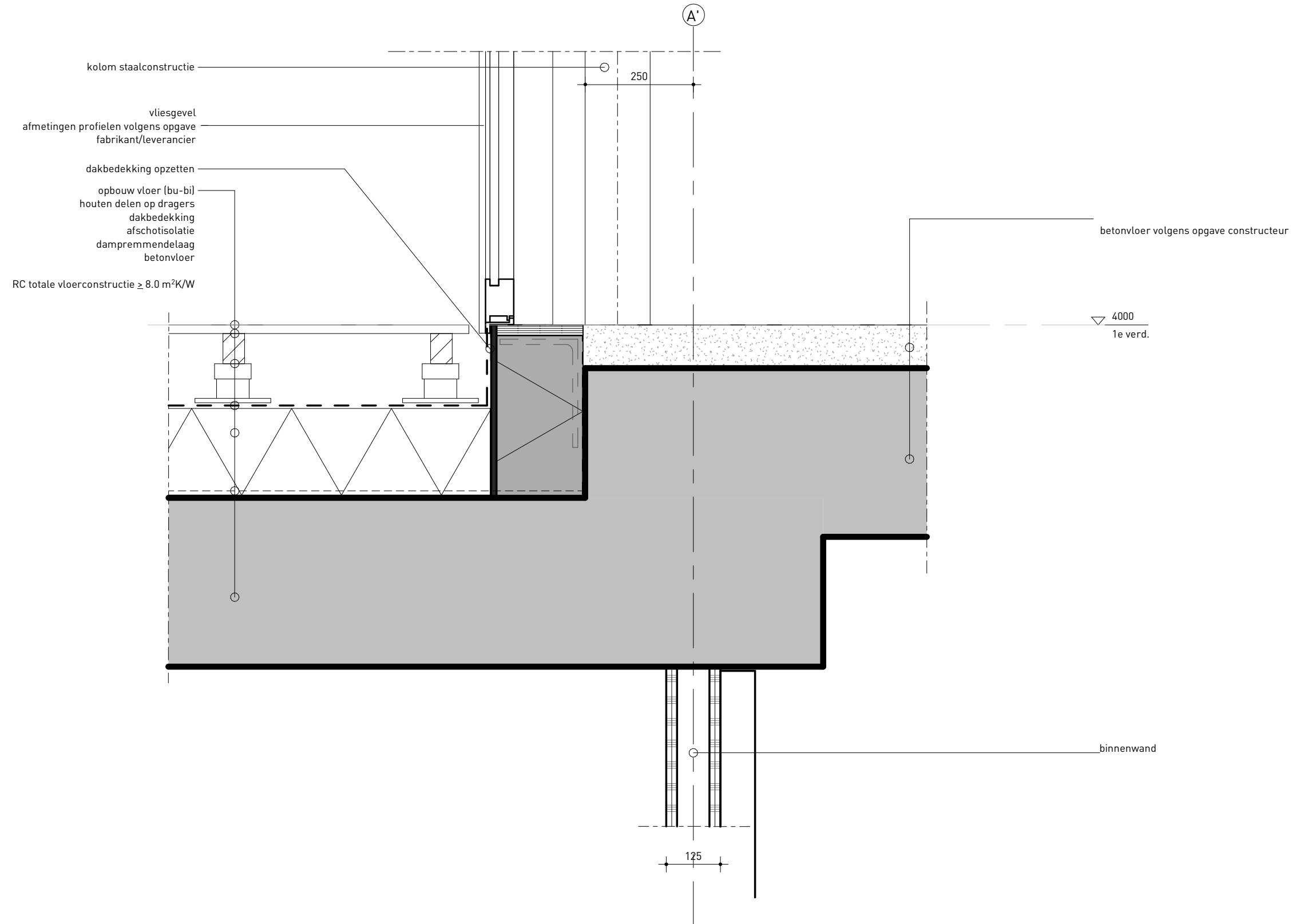

project: JRCZ Middelburg	datum: 17-12-2020	formaat: A3	getekend: HDC	status: U0
onderdeel: Principedetail D1	schaal: 1 : 10	infoniveau: 300	projectnr: PR19-03	document: U40-D1
contact: www.rothuizen.eu				

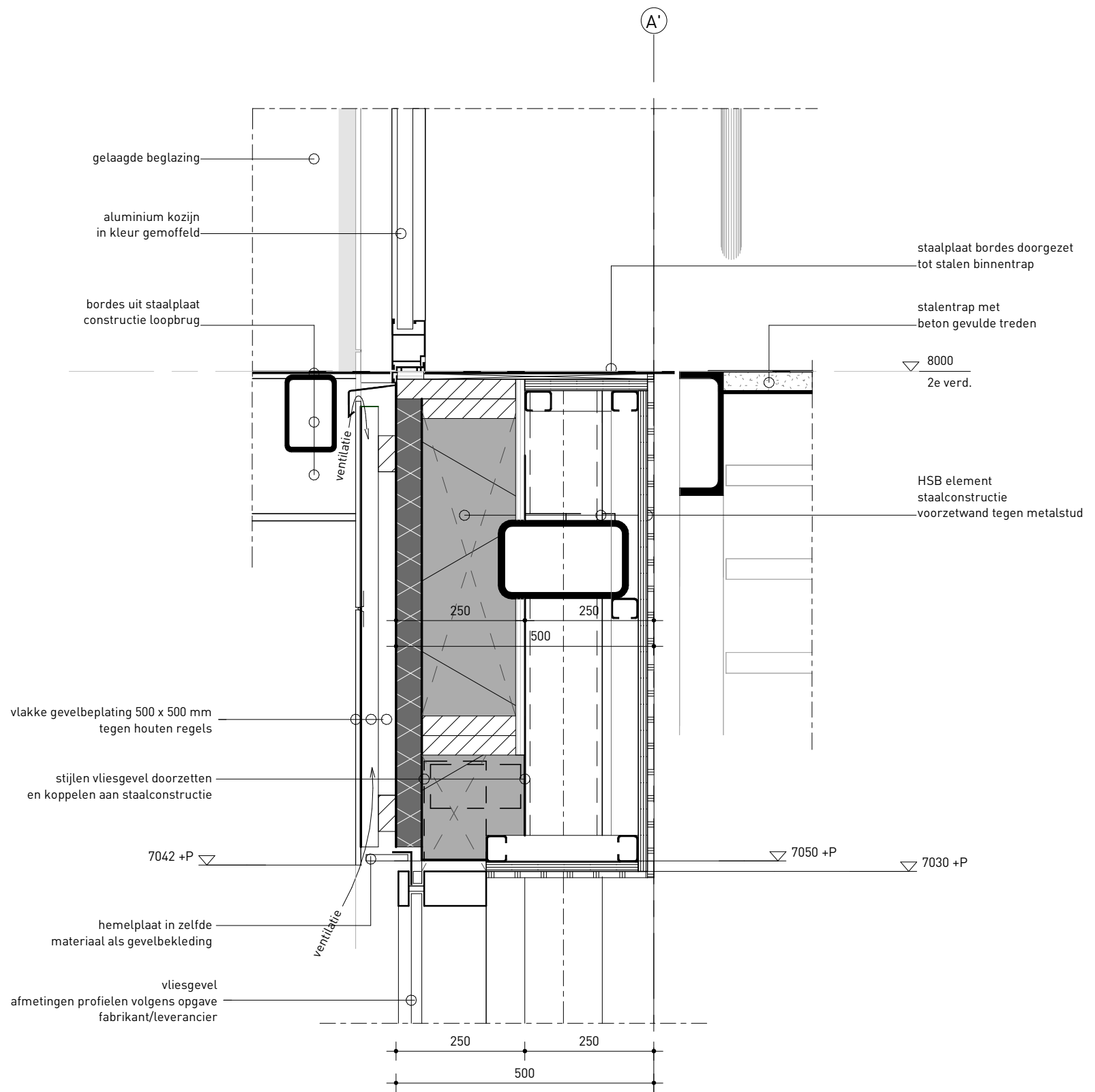

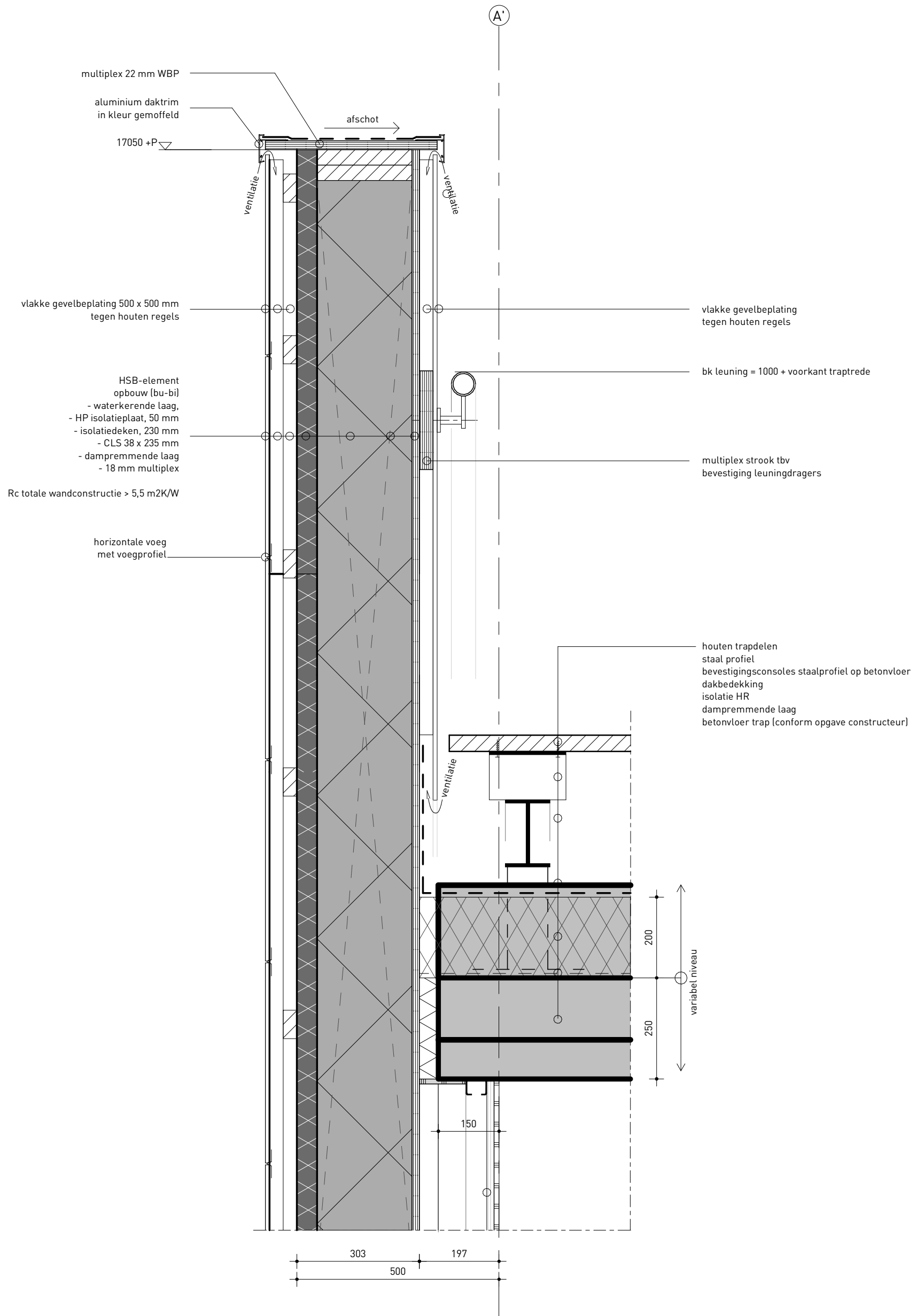

ROTHUIZEN

ARCHITECTEN STEDENBOUWKUNDIGEN



BOUWMEESTERPRO

project: **JRCZ Middelburg**
 onderdeel: **Principedetail D3**

datum: 17-12-2020

formaat: A3p

getekend: HDC

status: U0

contact: www.rothuizen.eu

schaal: 1 : 10

infoniveau: 300

projectnr: PR19-03

document: U40-D3

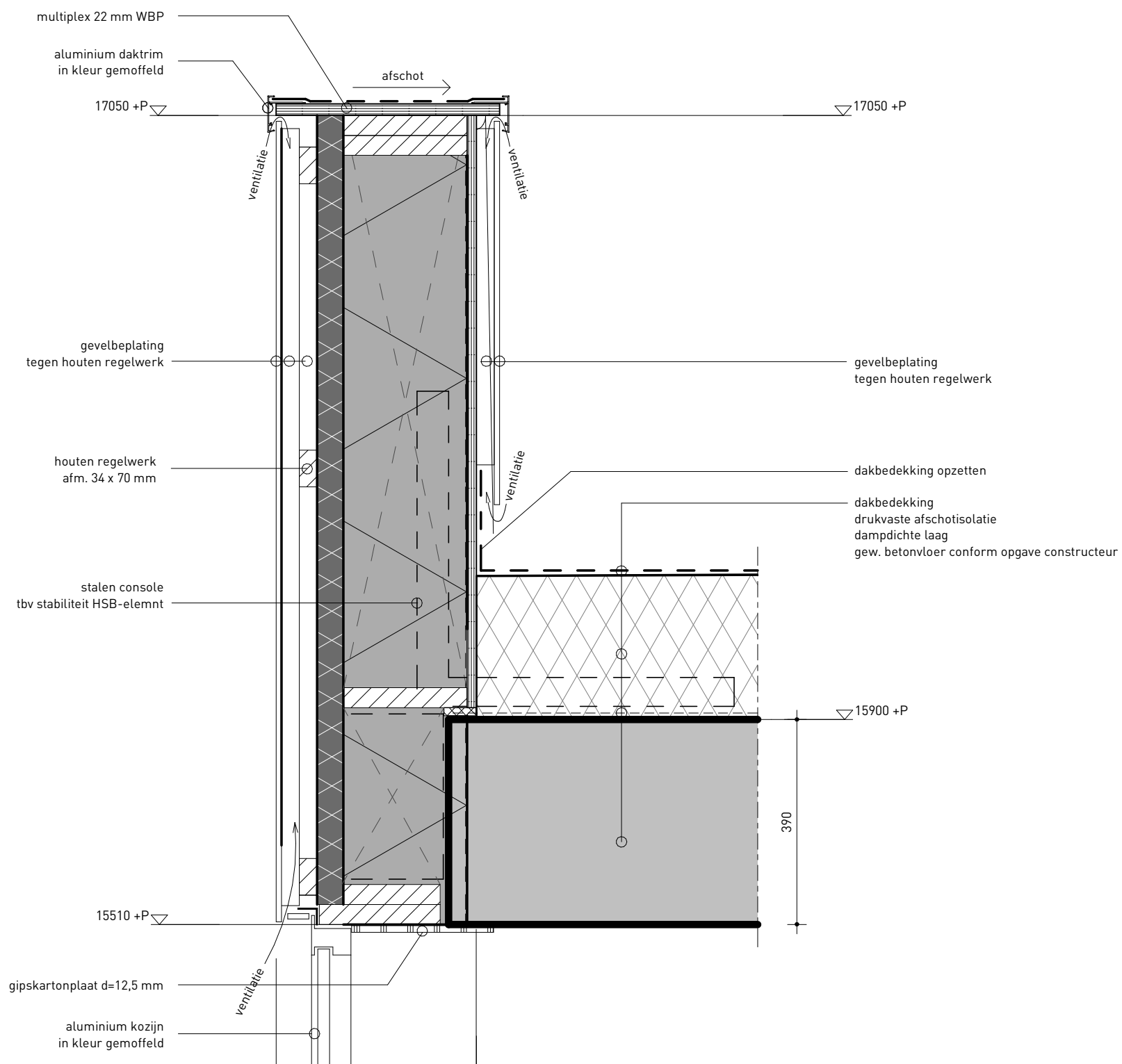

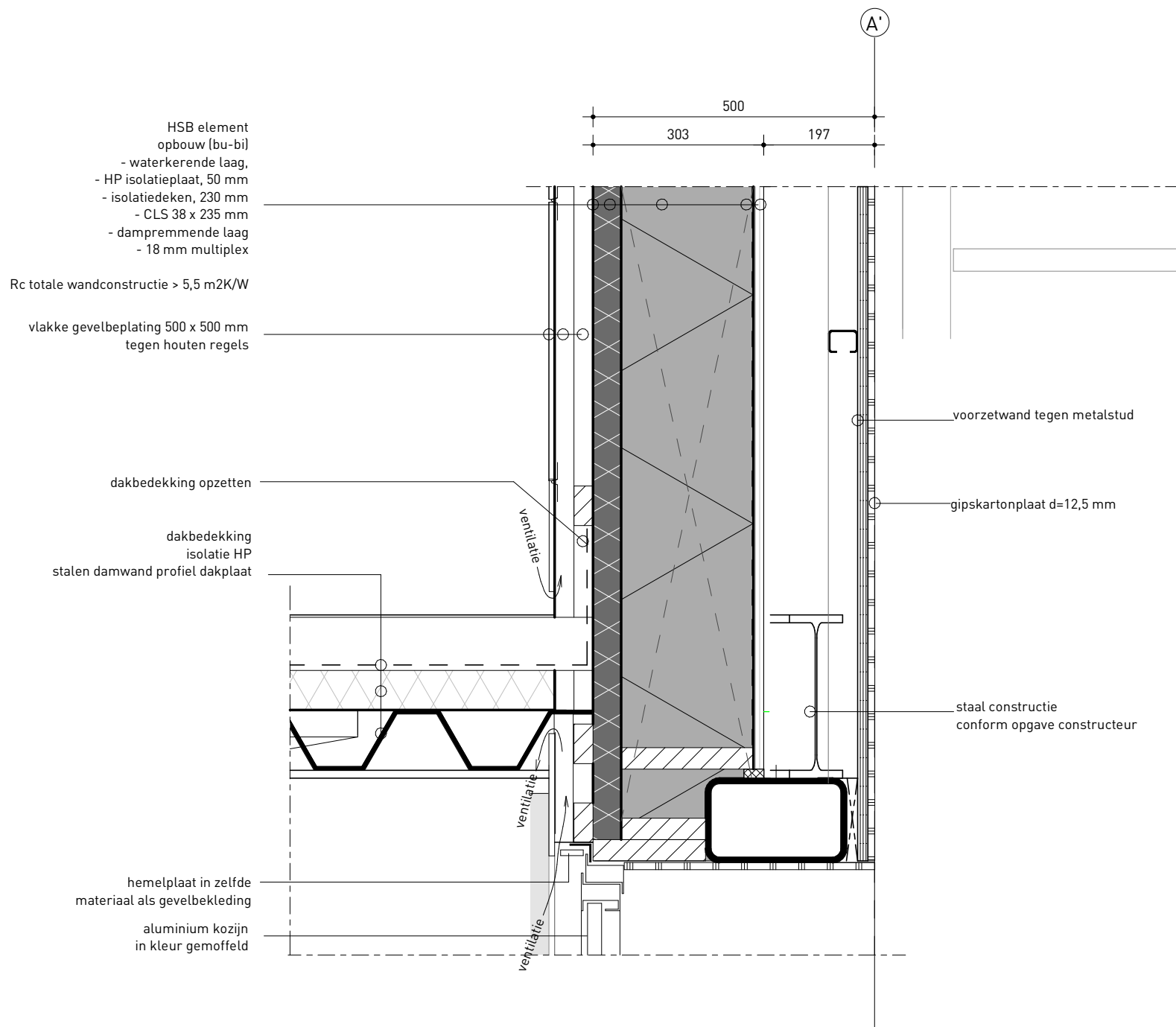

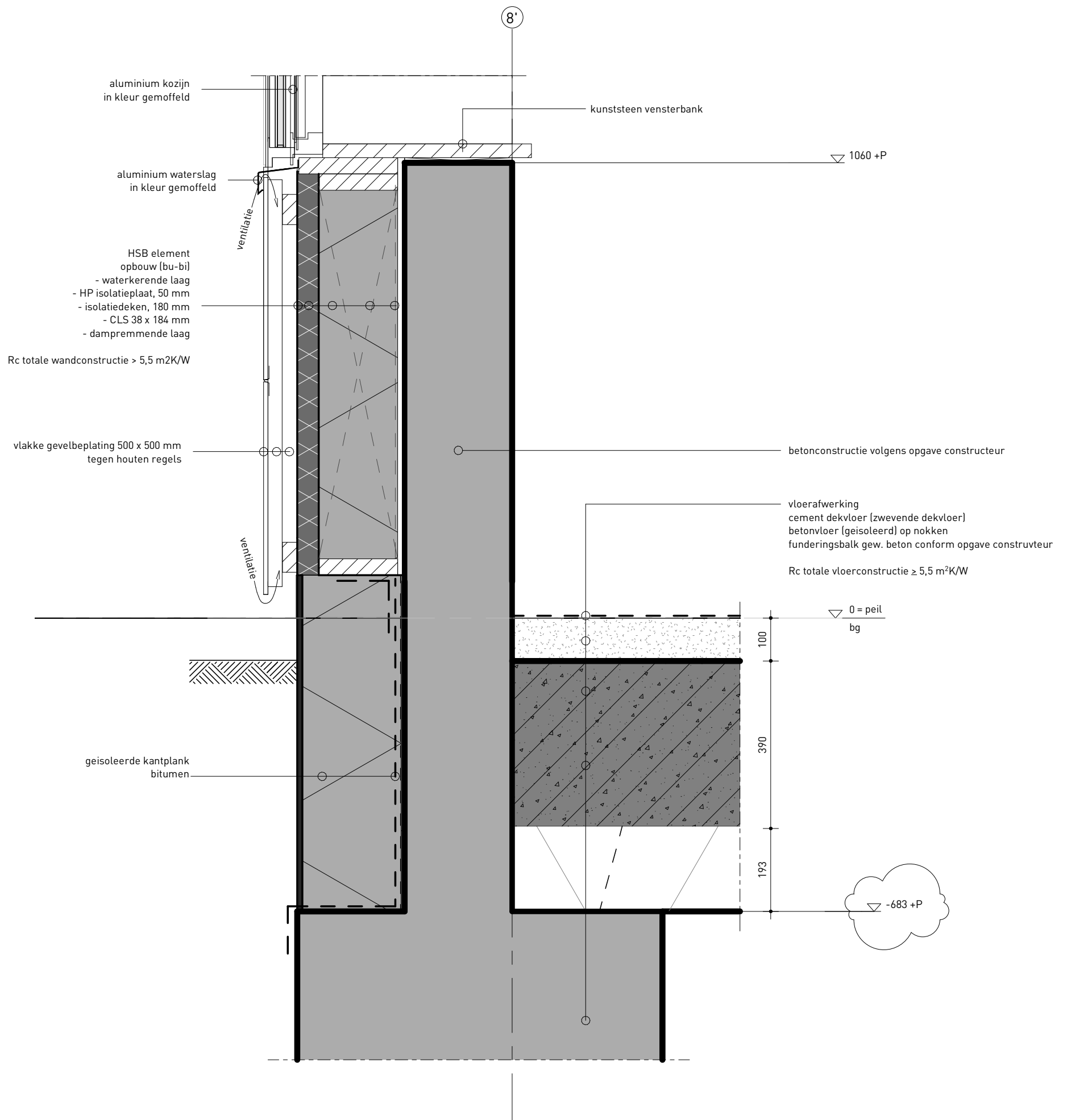

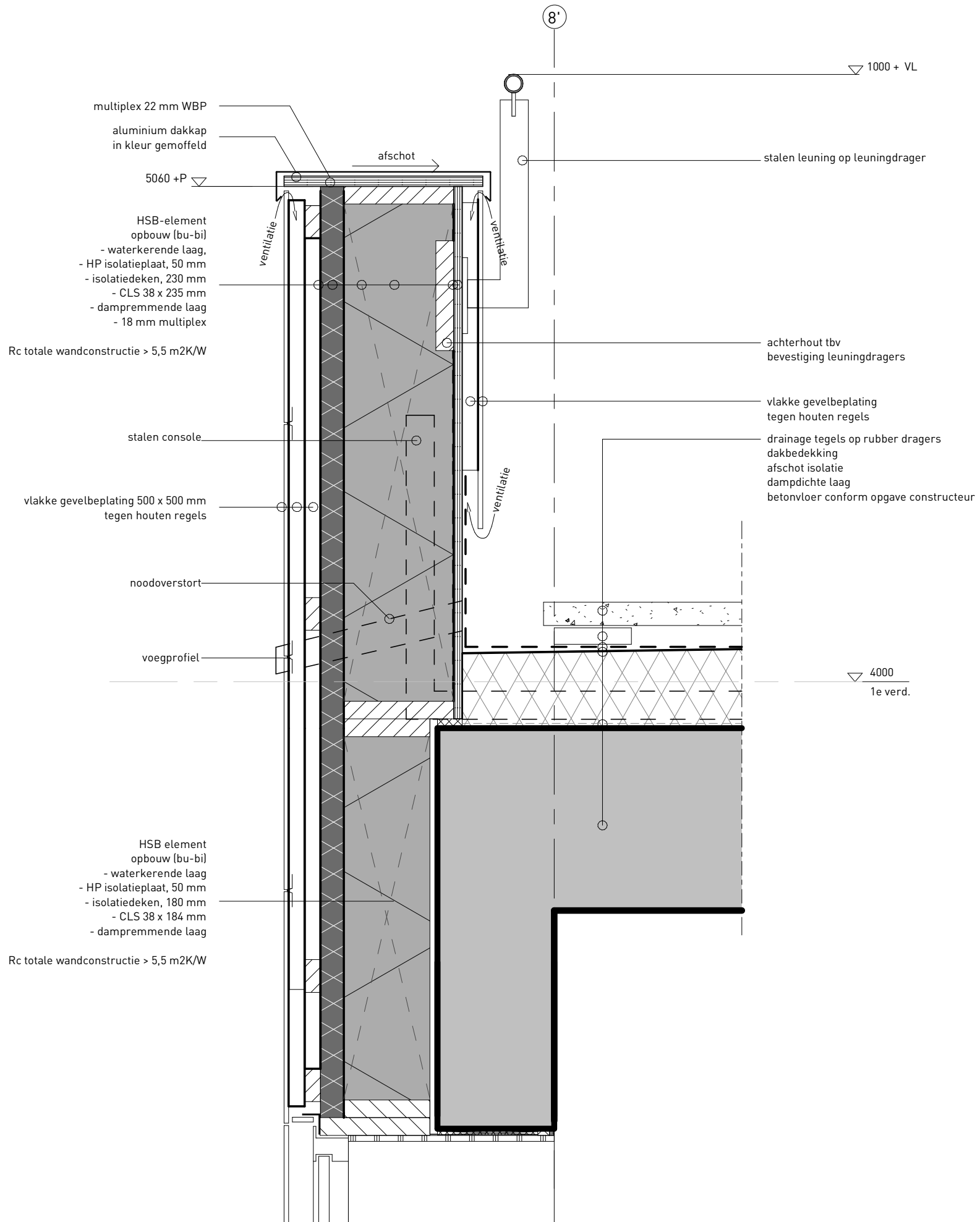

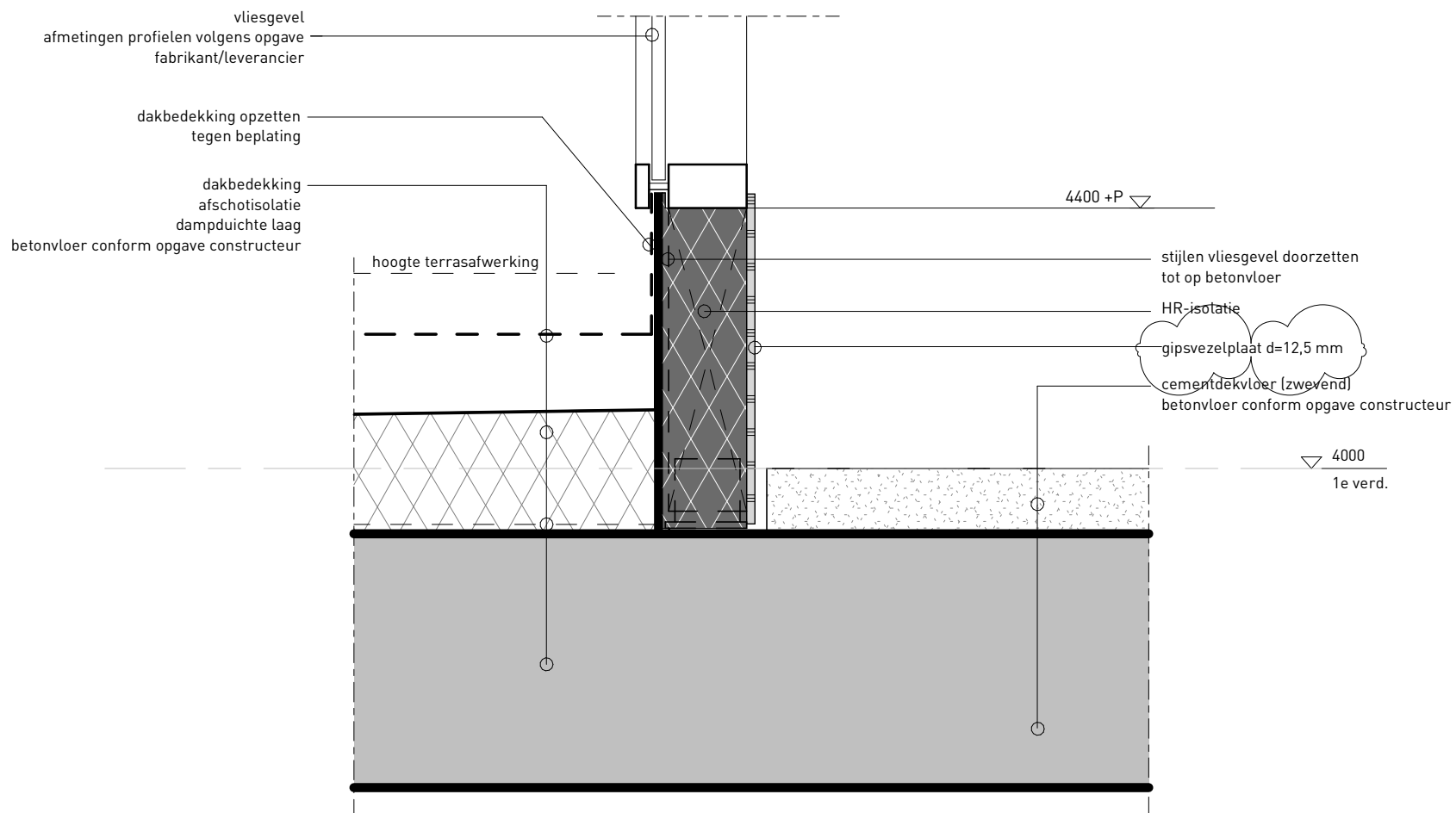

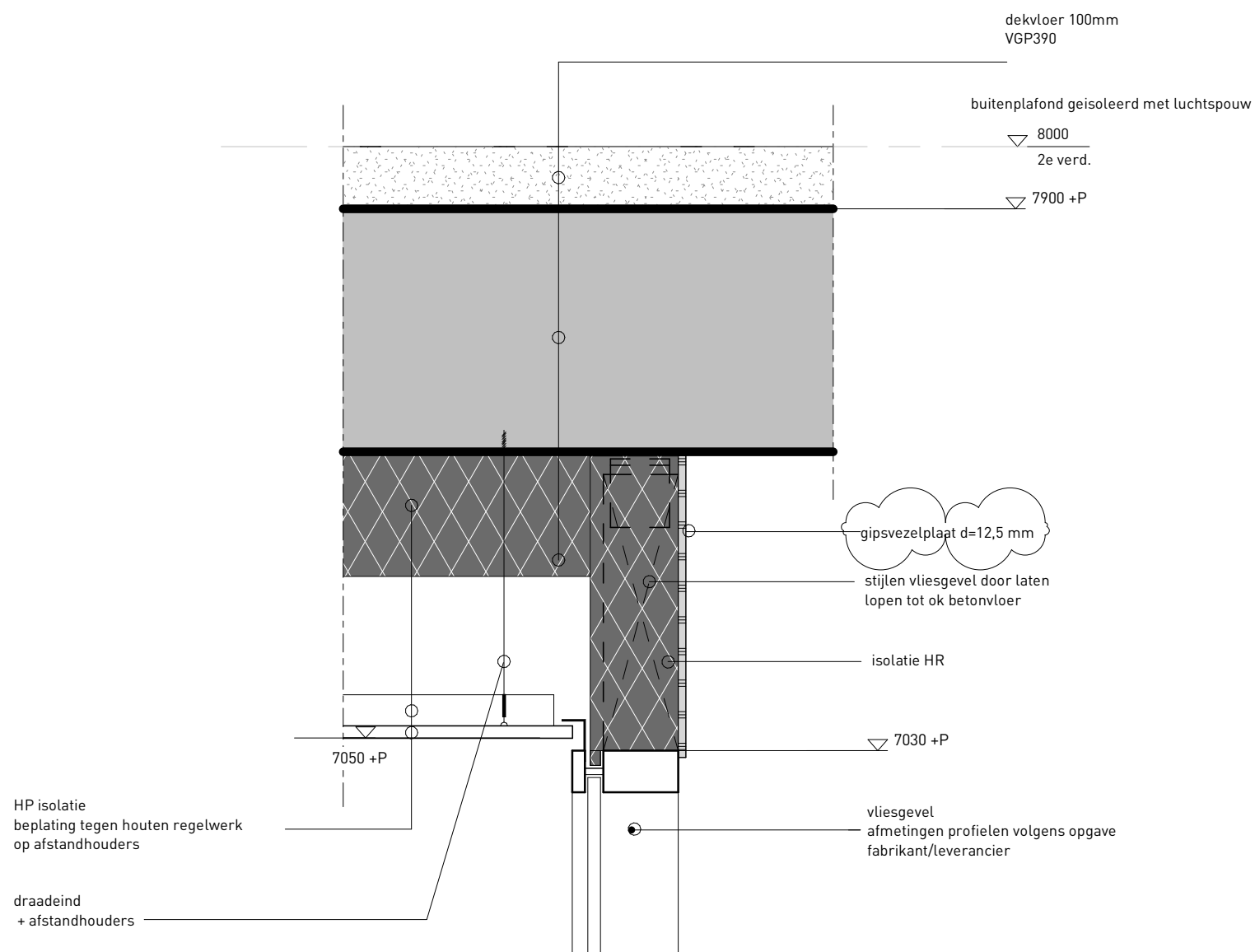

8

geluidwerende beplating

- HSB element opbouw (bu-bi)
- waterkerende laag
- HP isolatieplaat, 50 mm
- isolatiedeken, 230 mm
- CLS 38 x 235 mm
- dampremmende laag
- 18 mm multiplex

Rc totale wandconstructie > 5,5 m2K/W

horizontale voeg met voegprofiel

vlakke gevelbeplating 500 x 500 mm tegen houten regels

isolatie HSB-elementen doorzetten

ventilatie

staalconstructie vakwerk

vloerafwerking
 zwevende cement dekvloer conform opgave constructeur
 isolatie HP
 houten regelwerk
 beplating

▽ 8000
2e verd.

▽ 7900 +P

▽ 7050 +P

100

390

460



project: JRCZ Middelburg	datum: 17-12-2020	formaat: A3p	getekend: HDC	status: U0
onderdeel: Principedetail F3	schaal: 1 : 10	infoniveau: 300	projectnr: PR19-03	document: U40-F3
contact: www.rothuisen.eu				

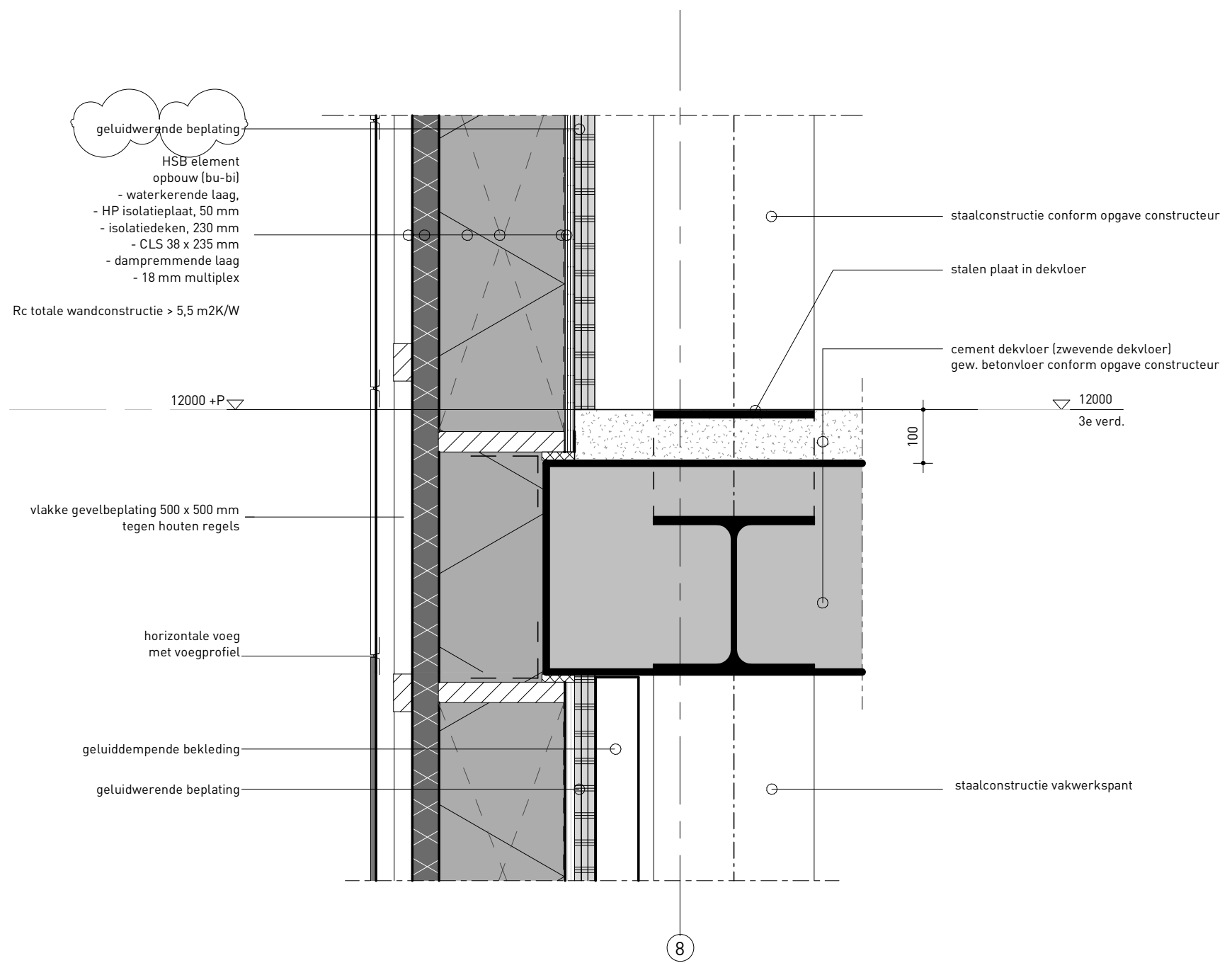

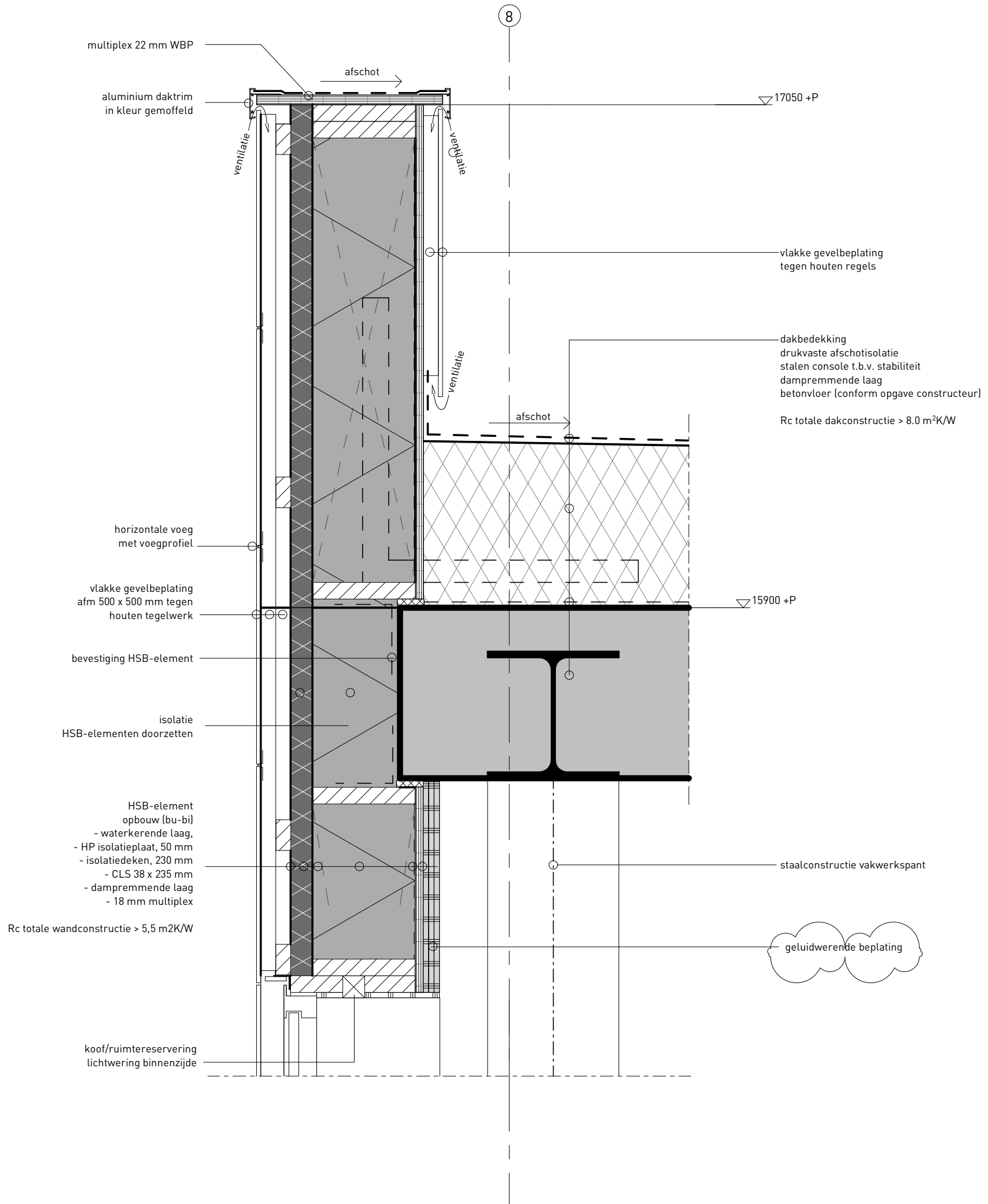

opbouw (bu-bi)
 - waterkerende laag
 - HP isolatieplaat, 50 mm
 - isolatiedeken, 230 mm
 - CLS 38 x 235 mm
 - dampremmende laag

Rc totale wandconstructie > 5,5 m²K/W

regelwerk gevelbekleding afsteunen
 tegen HSB-element betonwand

1200 +P

geisoleerde kantplank
 bitumen

betonconstructie conform opgave constructeur

vloerafwerking
 cement dekvloer (zwevend)
 dampdichte laag
 geisoleerde betonvloer conform opgave constructeur
 funderingsbalk gew. beton

0 +P = peil

100

-680 +P

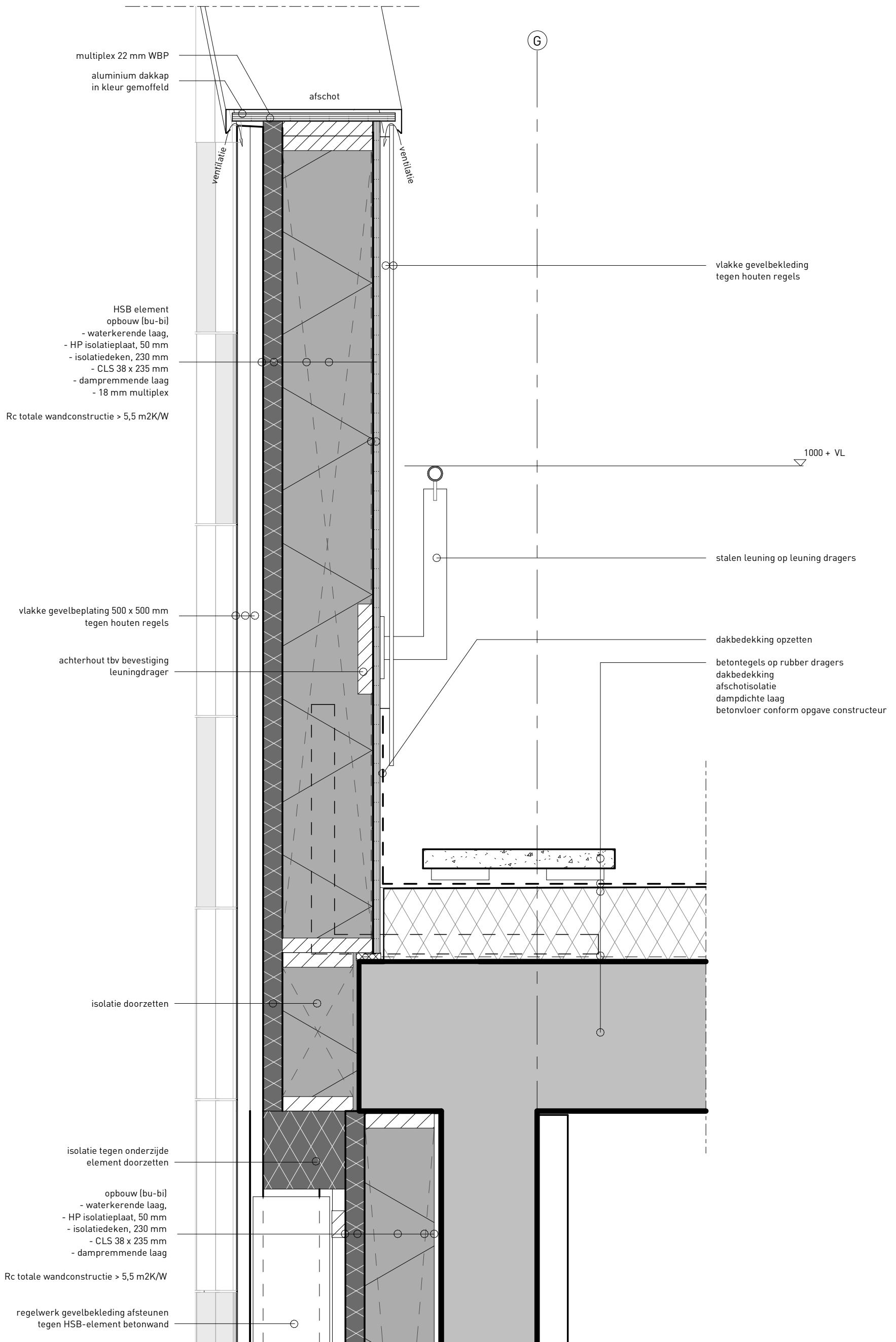

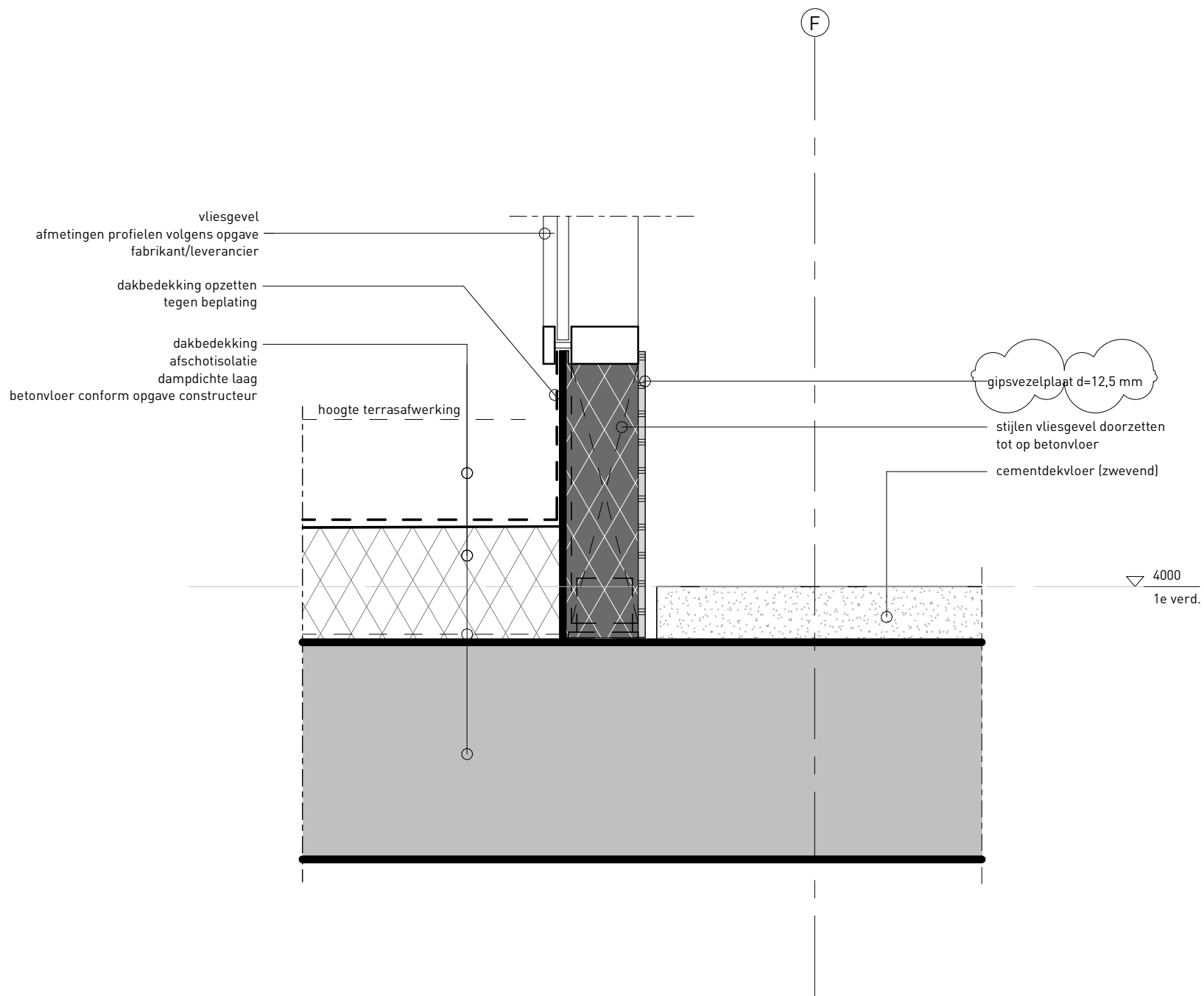

F

HSB element
opbouw (bu-bi)
- waterkerende laag,
- HP isolatieplaat, 50 mm
- isolatiedeken, 230 mm
- CLS 38 x 235 mm
- dampremmende laag
- 18 mm multiplex

Rc totale wandconstructie > 5,5 m²K/W

vlakke gevelbeplating 500 x 500 mm
tegen houten regels

stijlen vliesgevel doorzetten
en koppelen aan staalconstructie

7042 +P

hemelplaat in zelfde
materiaal als gevelbekleding

vliesgevel
afmetingen profielen volgens opgave
fabrikant/leverancier

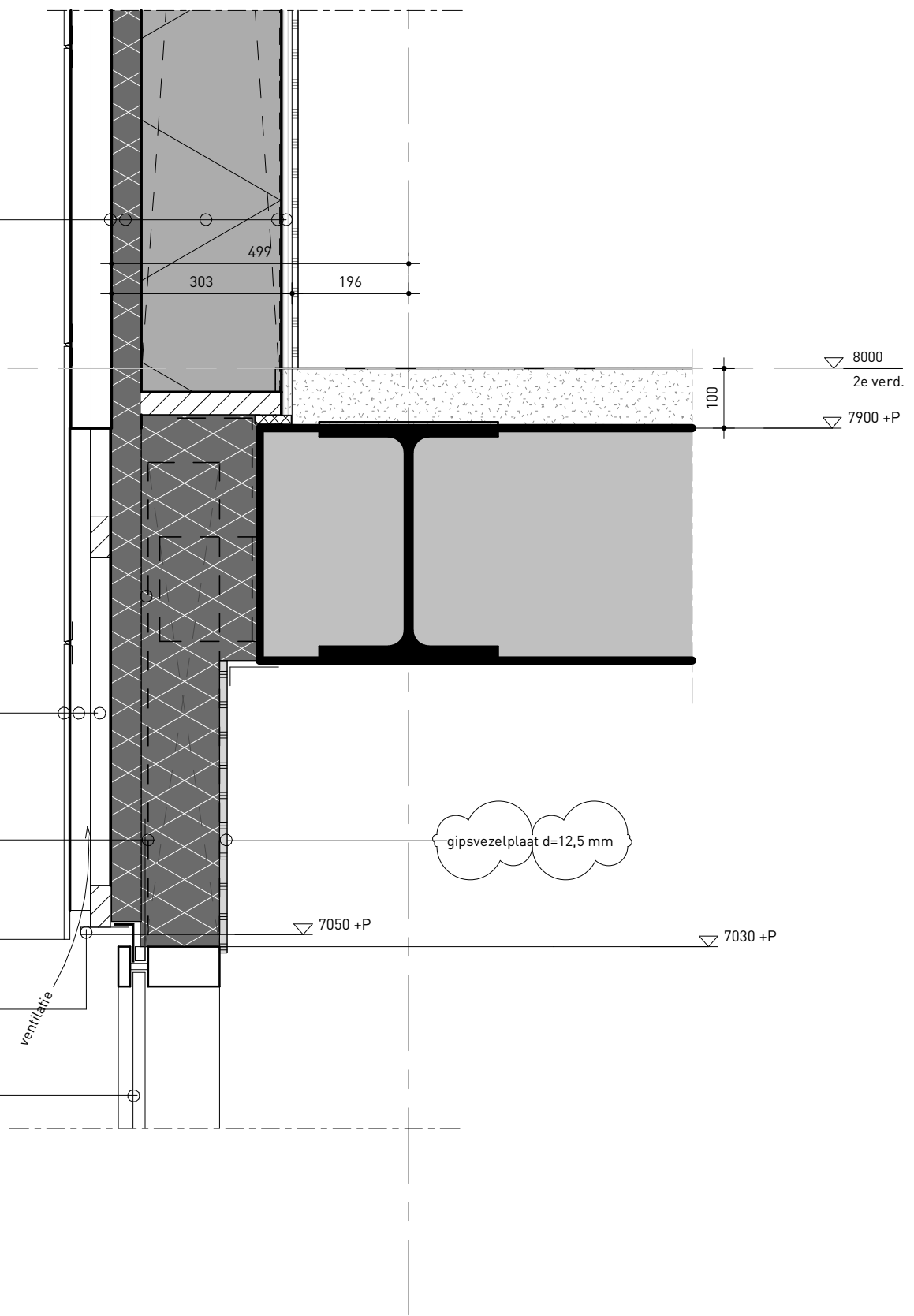

gipsvezelplaat d=12,5 mm

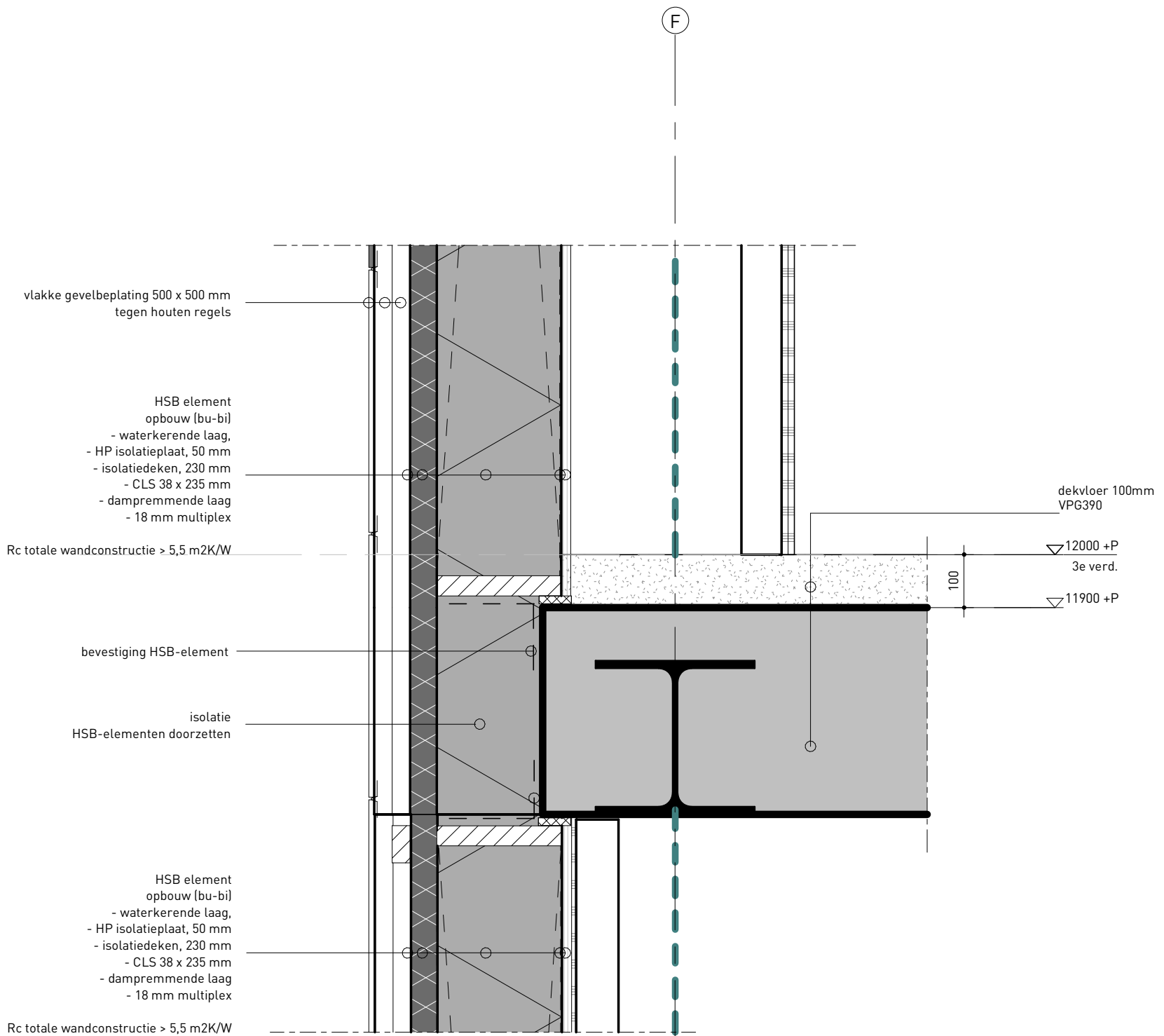

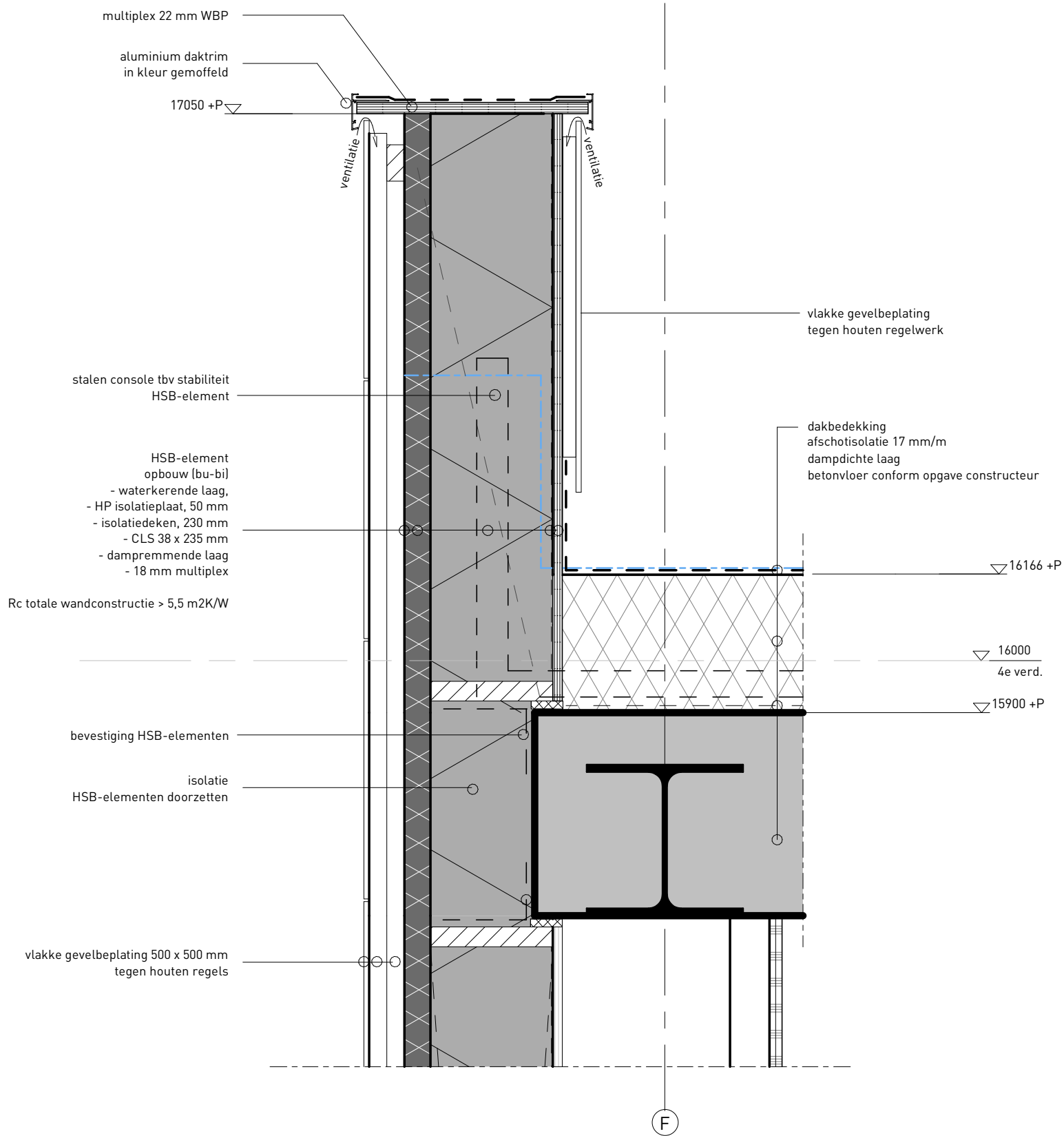

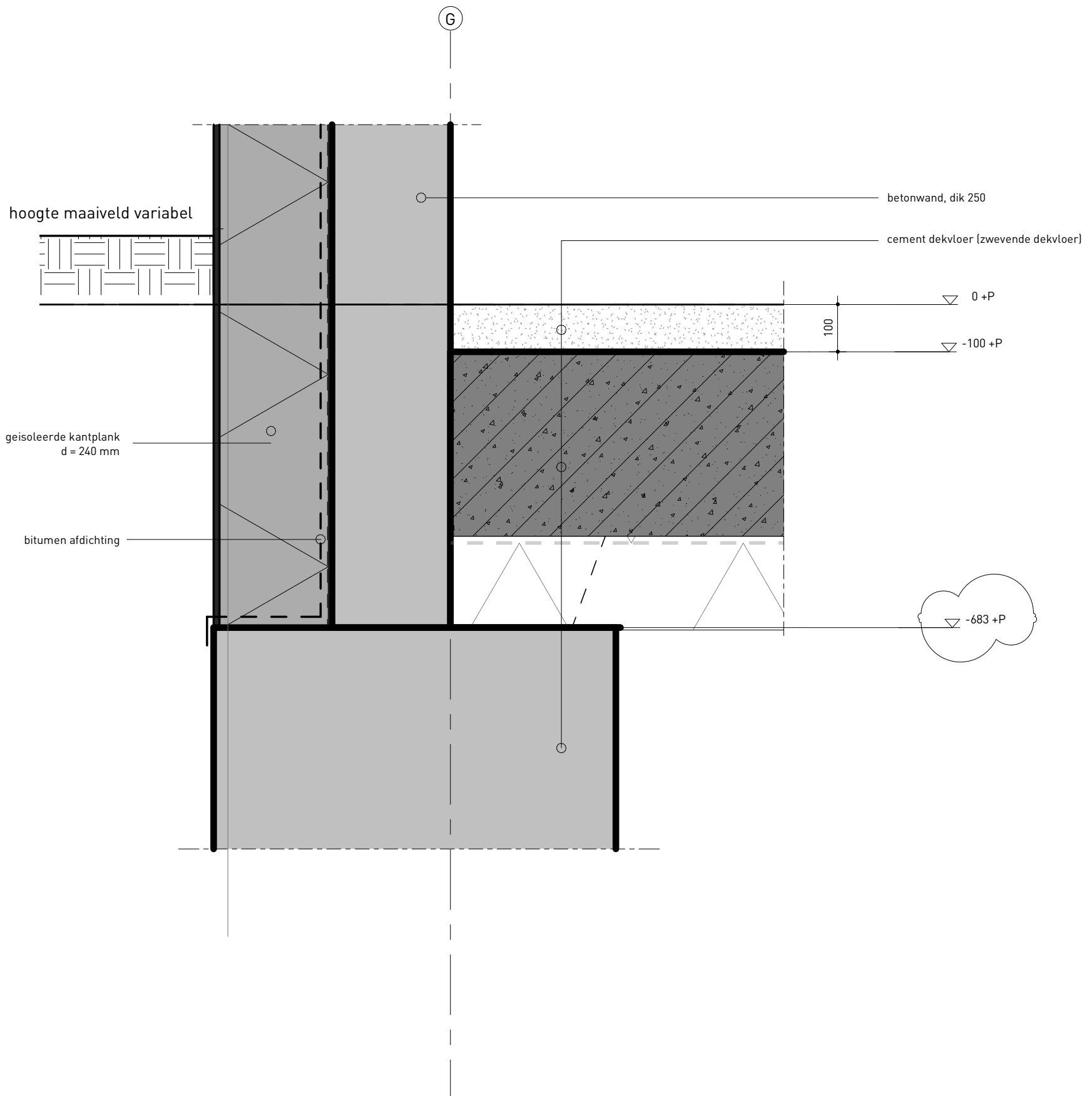

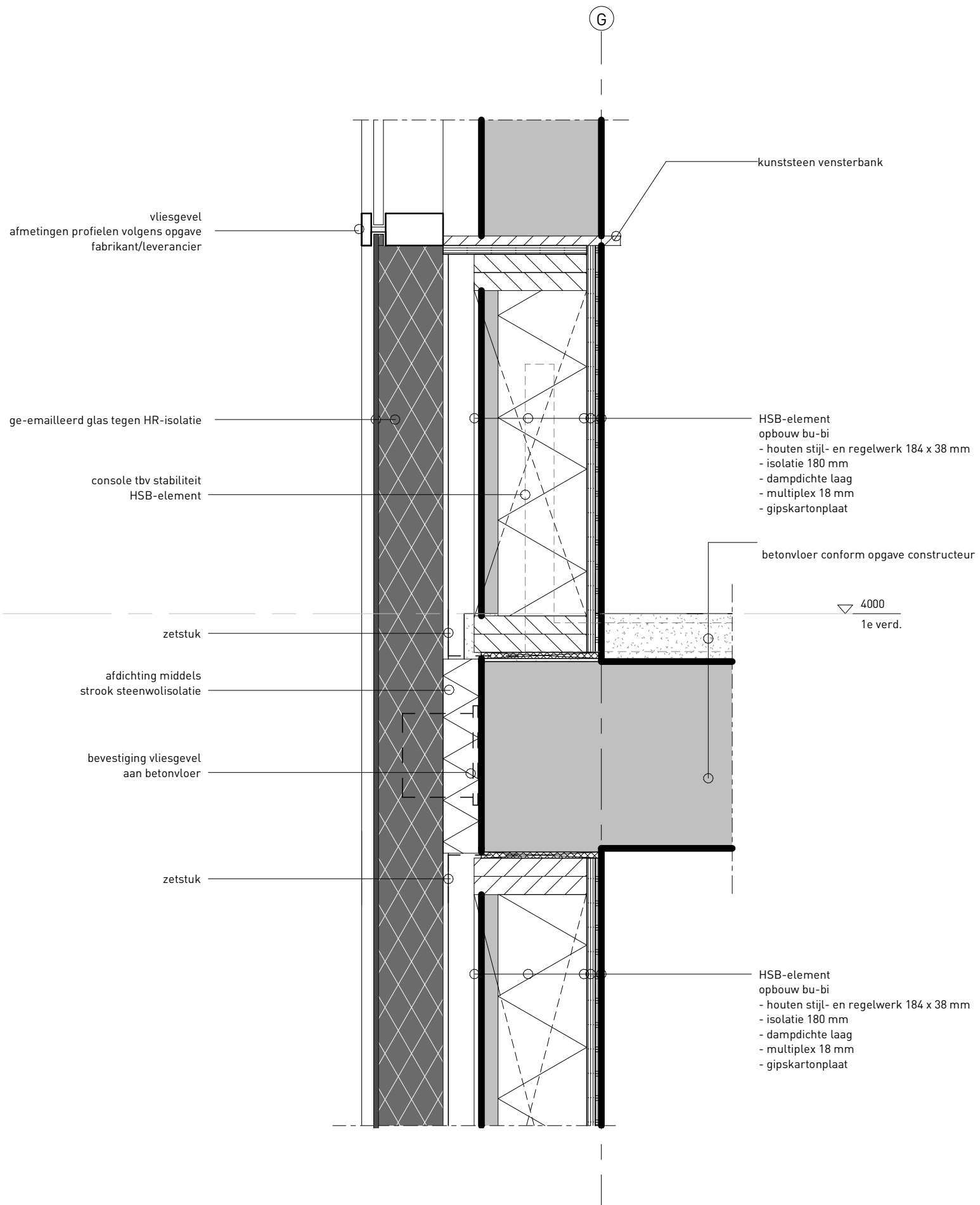

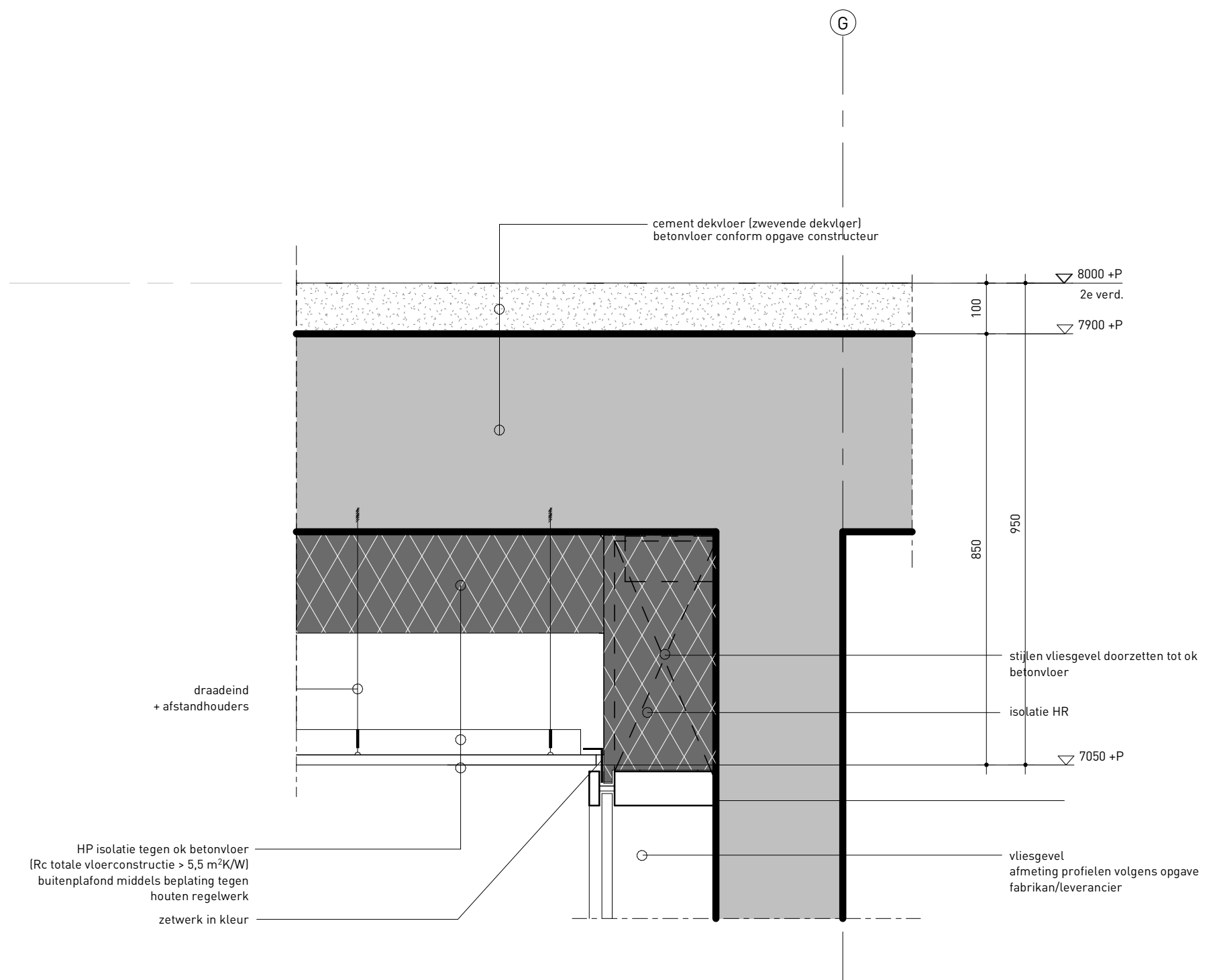

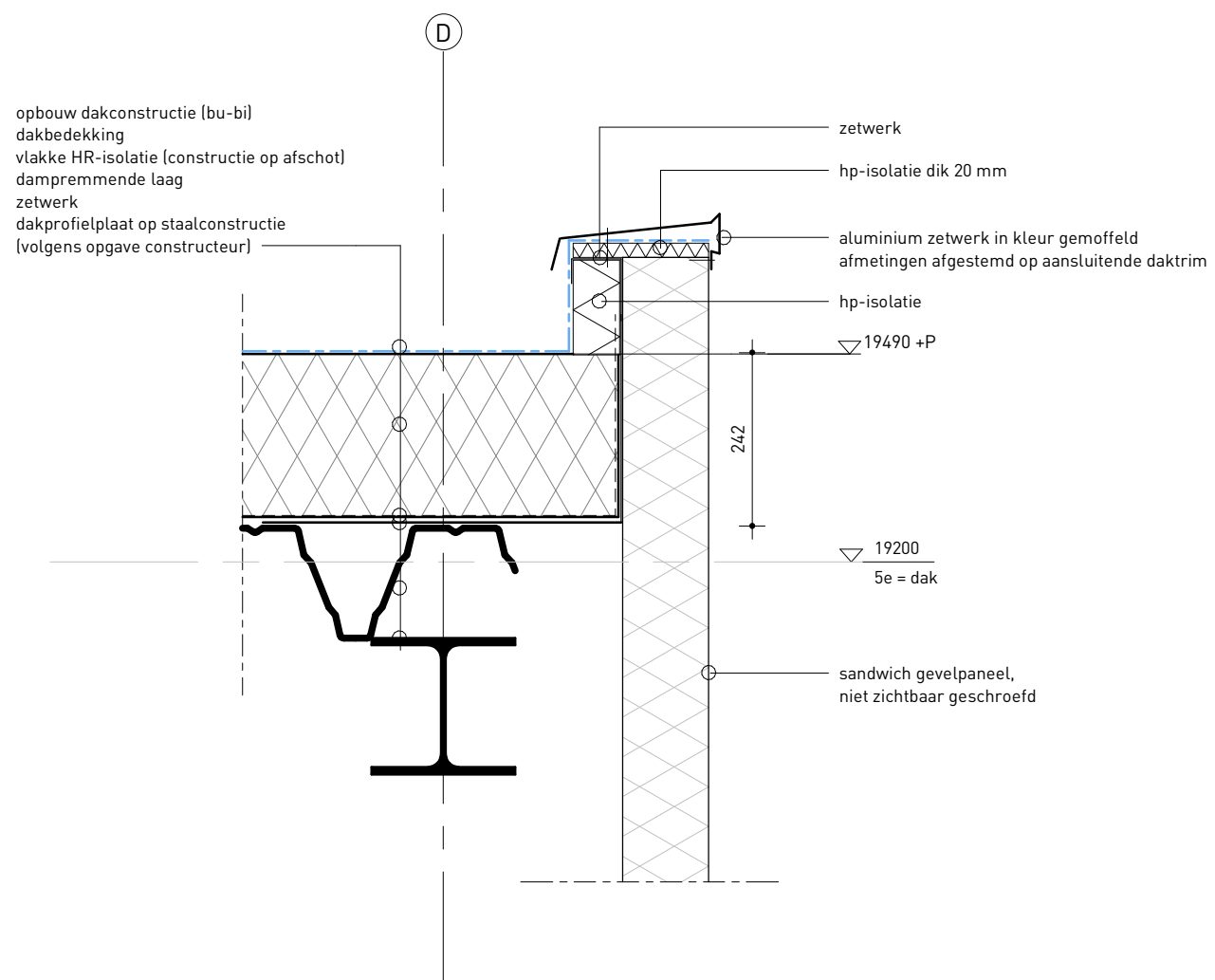

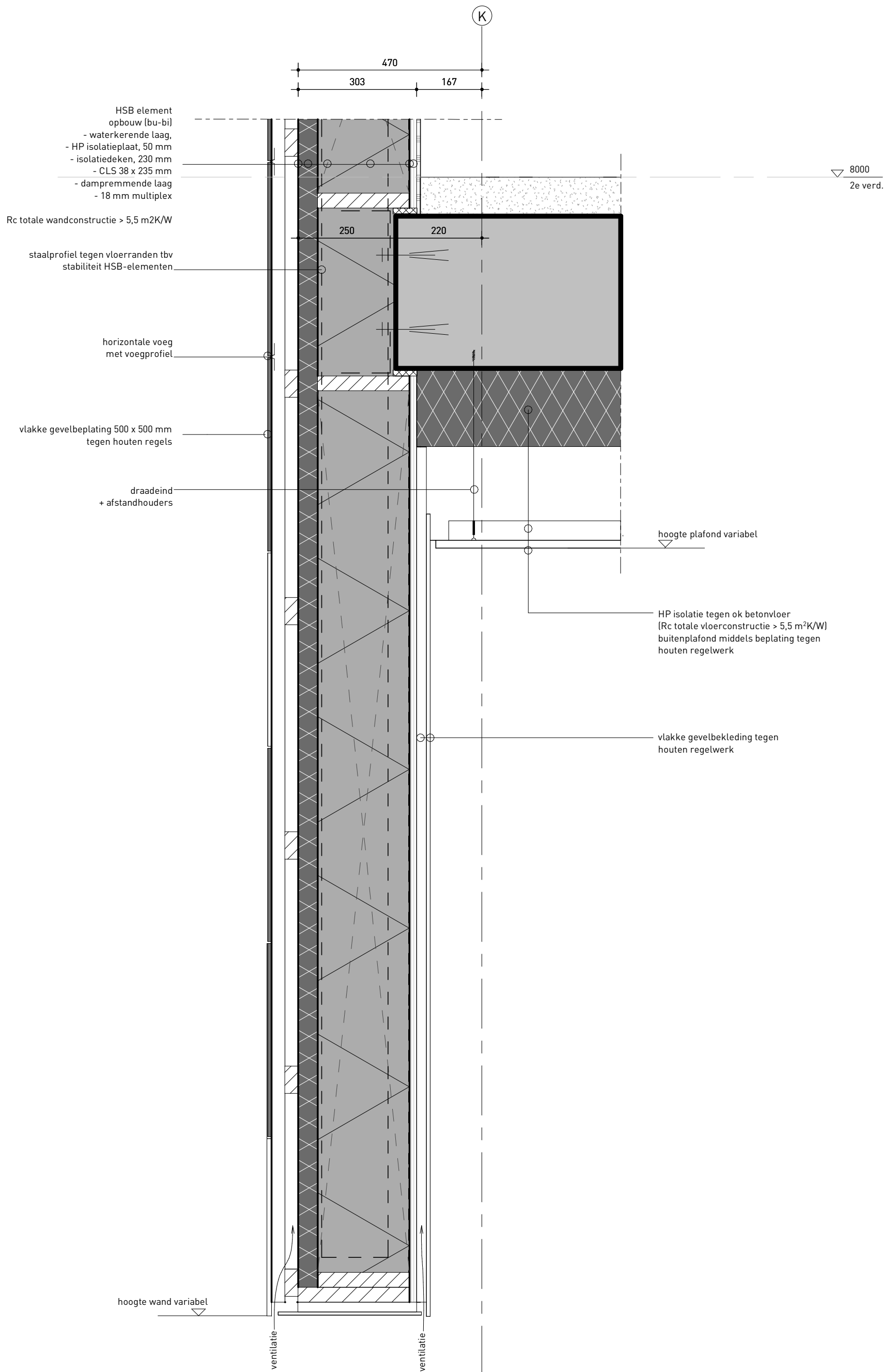

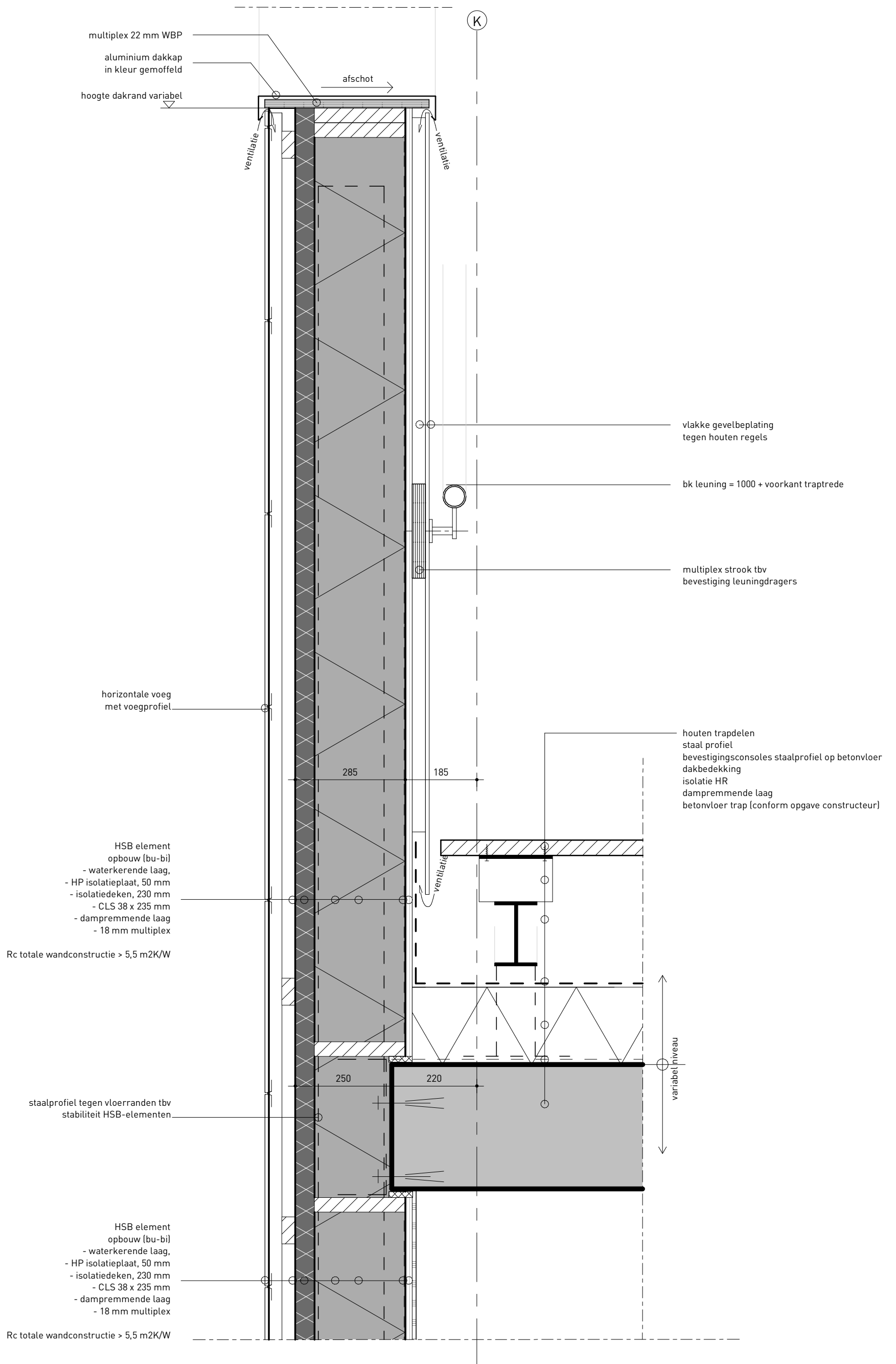

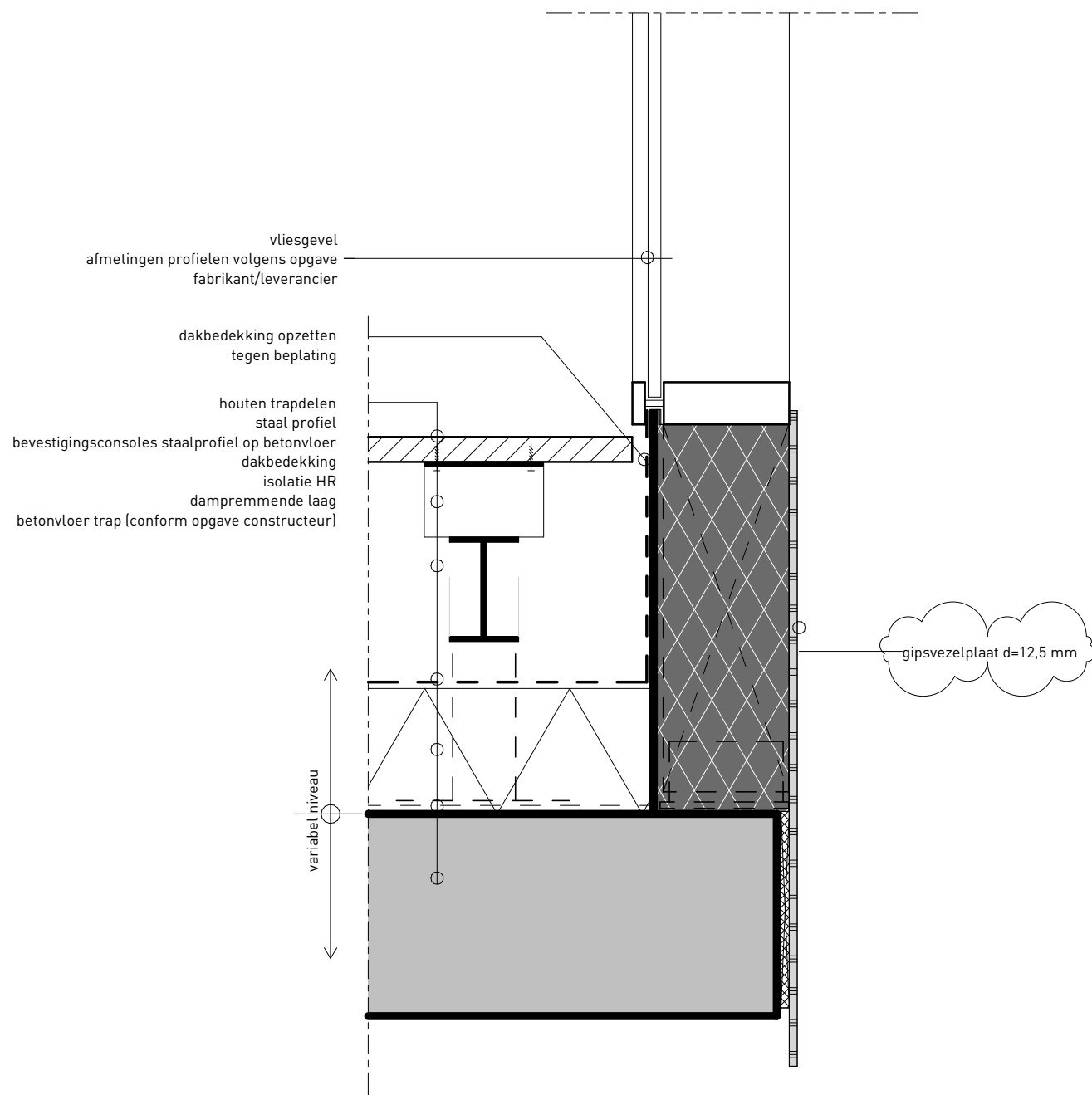

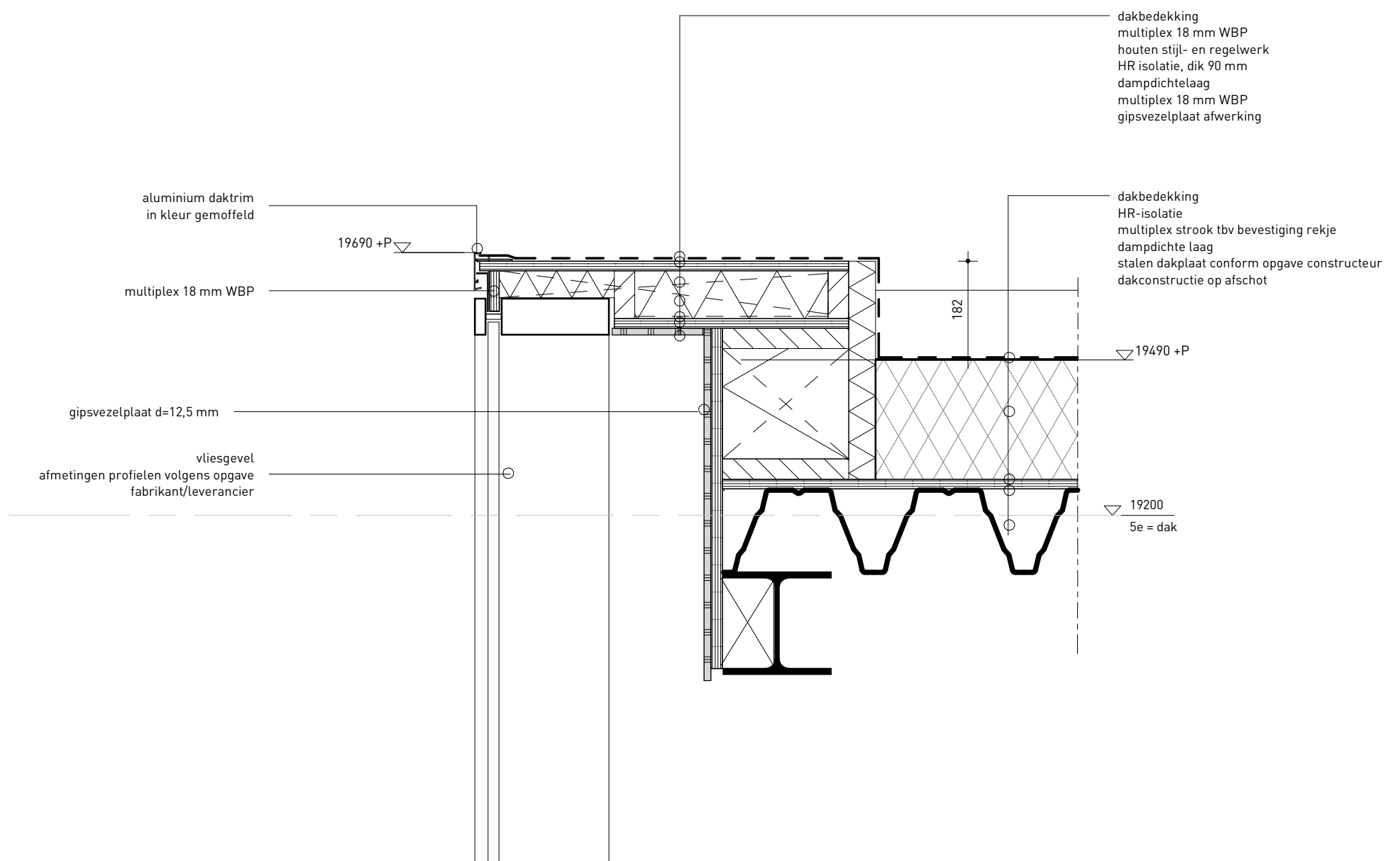

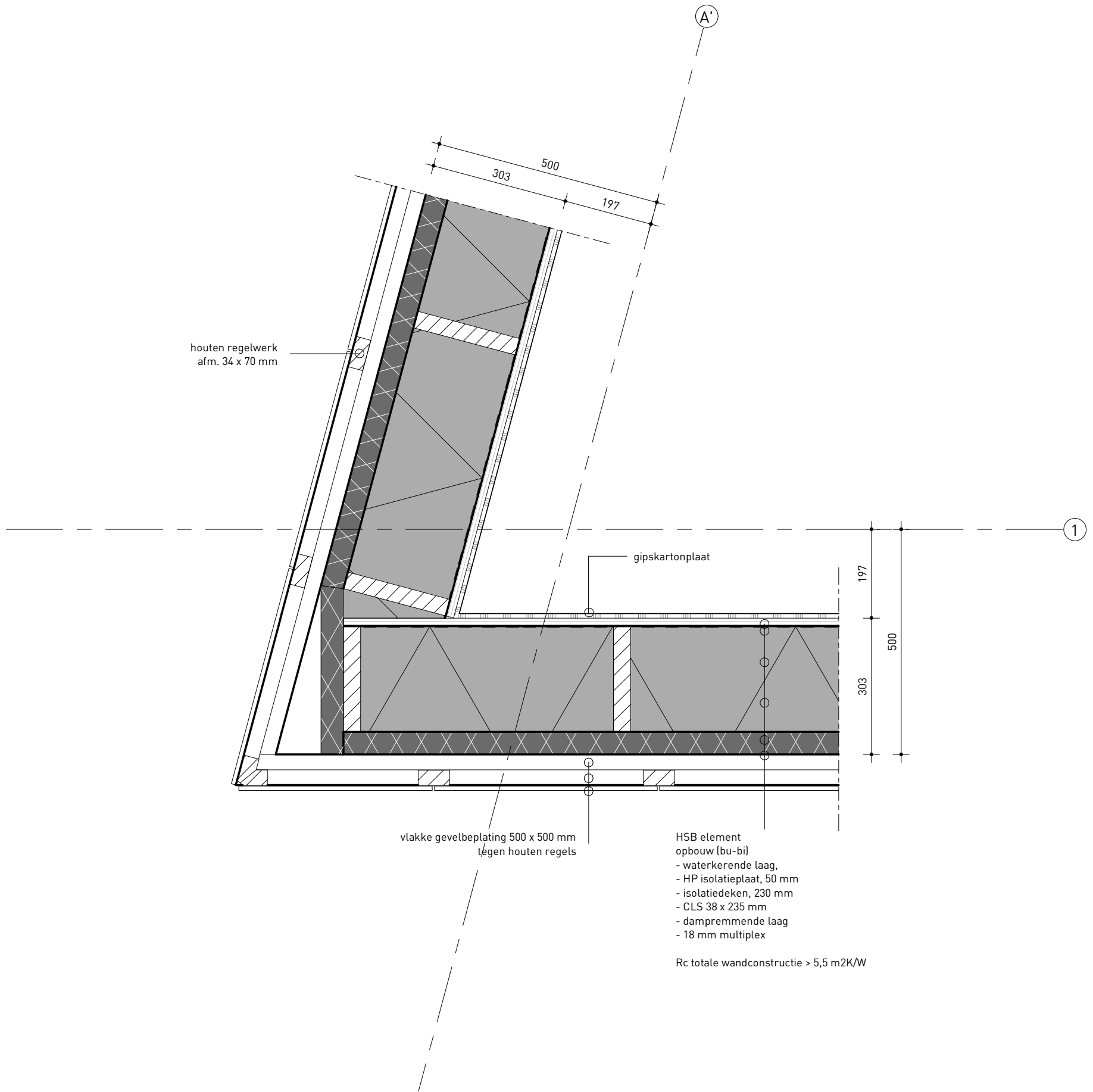

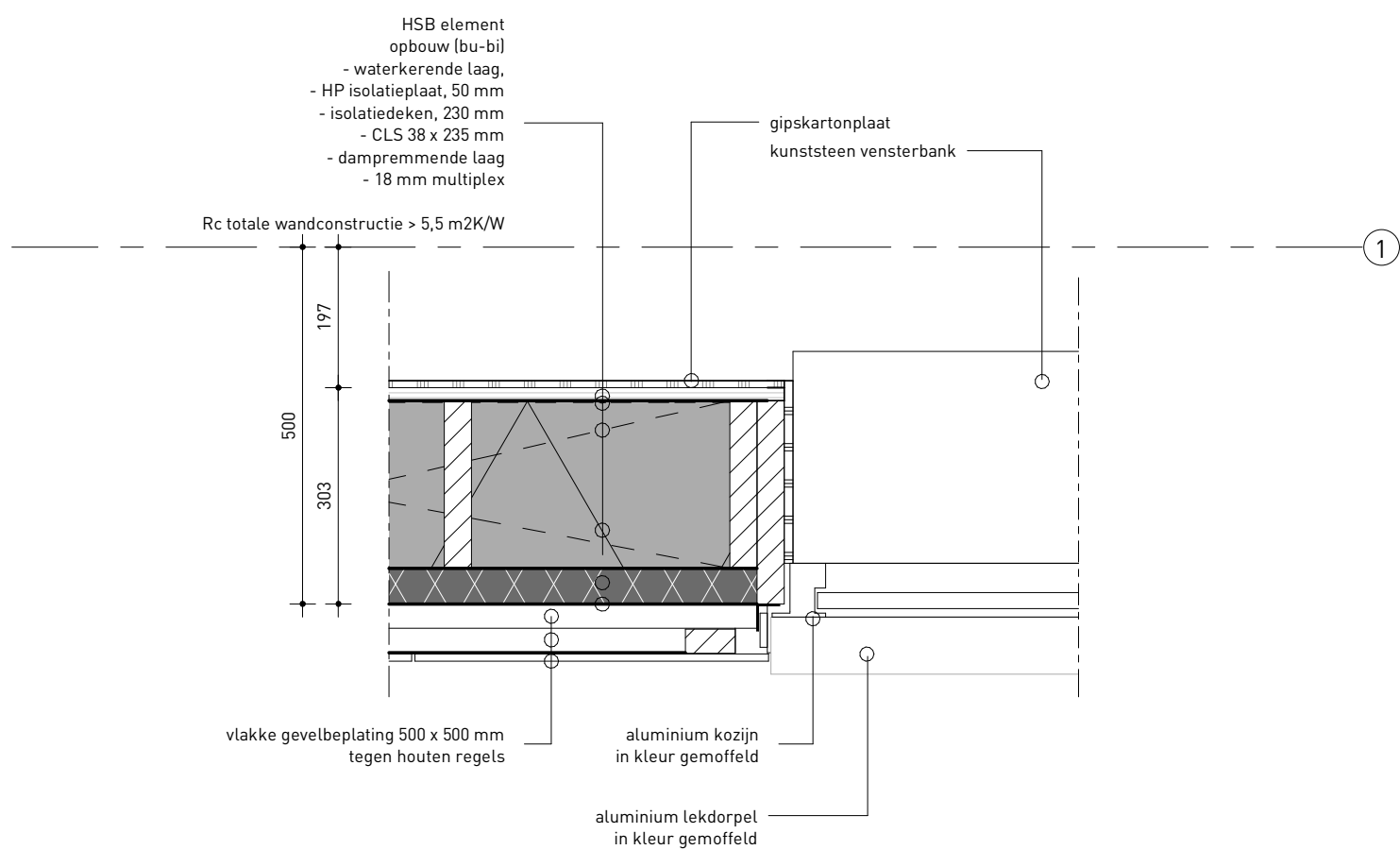

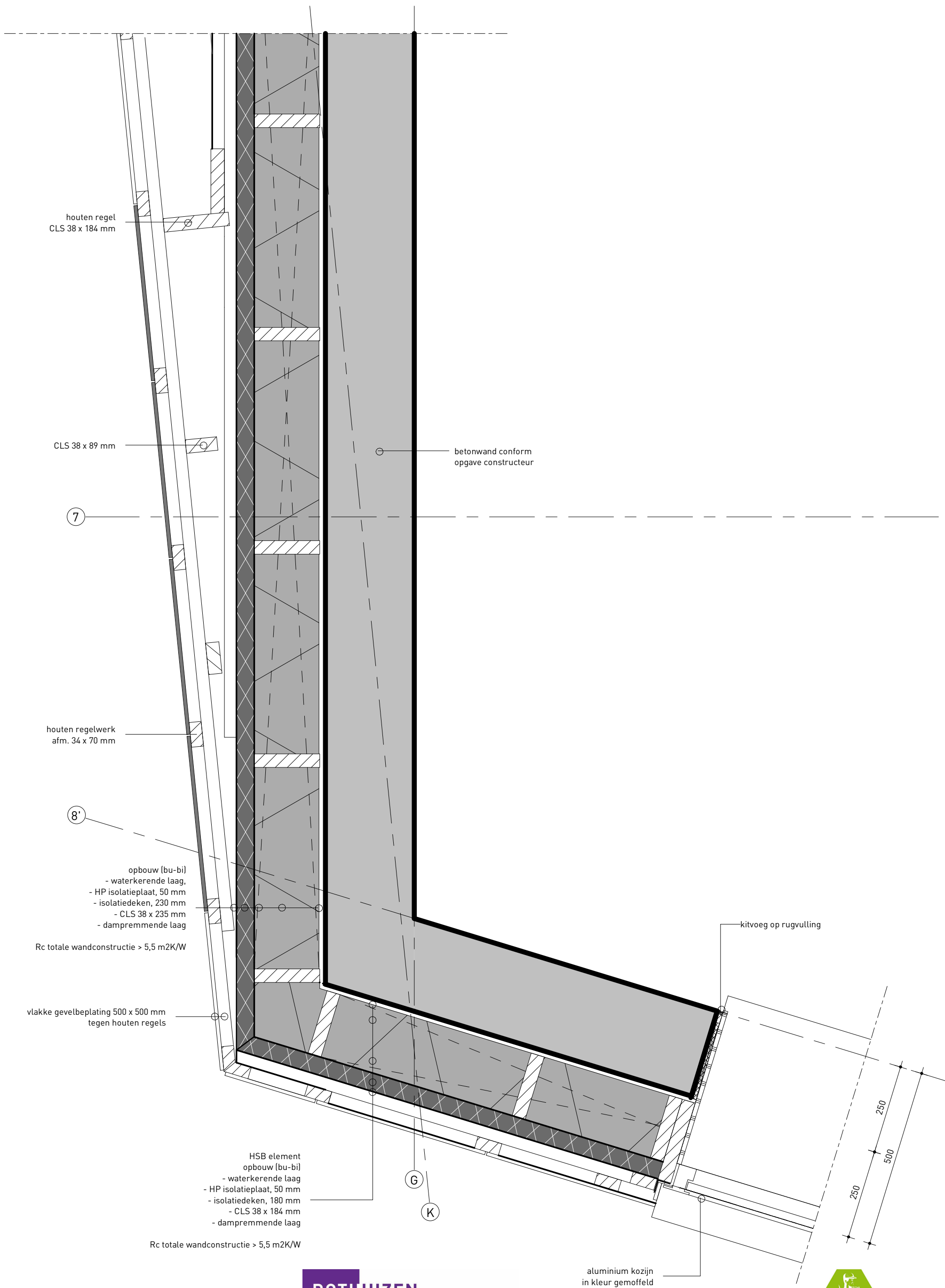

B

2

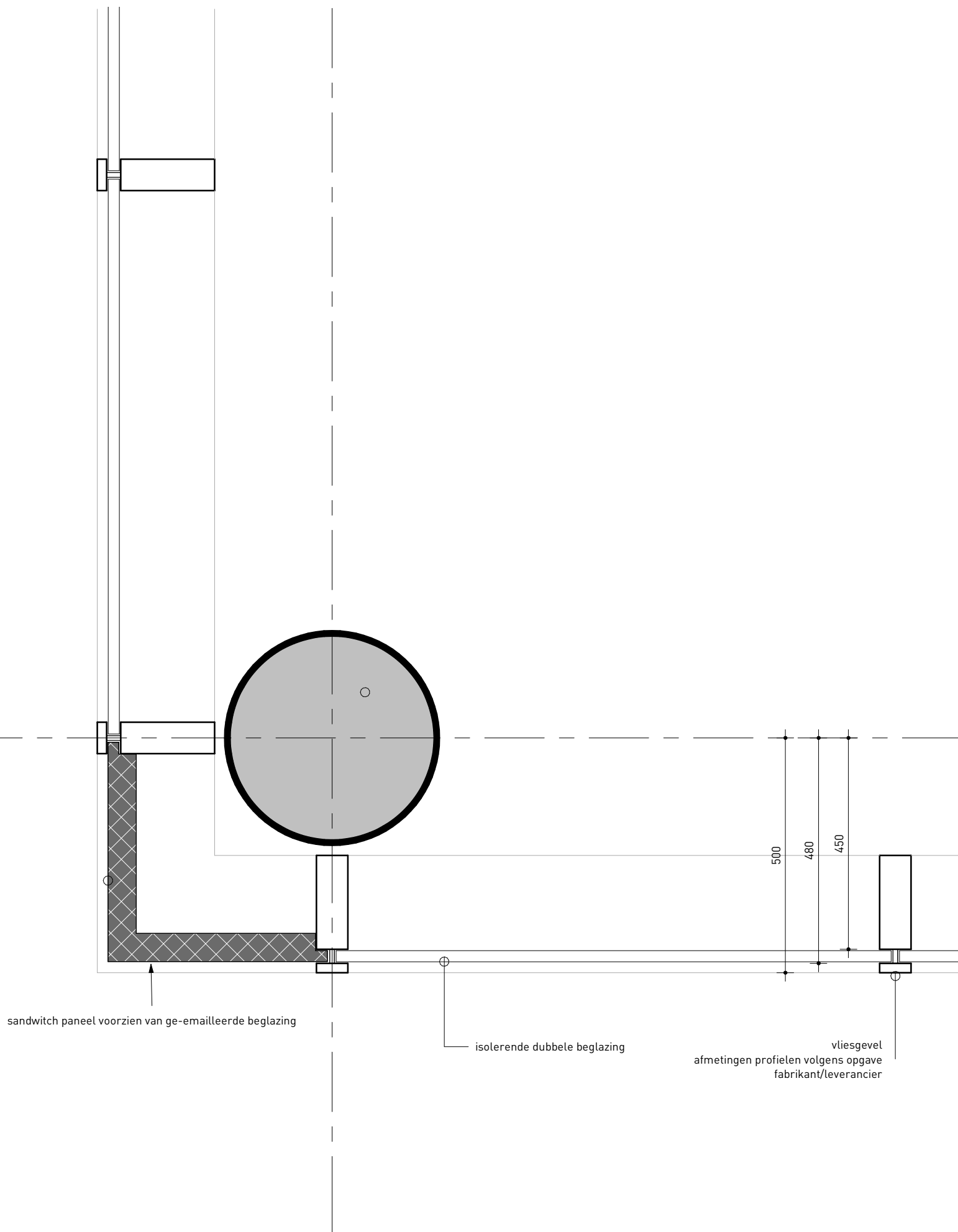

sandwich paneel voorzien van ge-ëmailleerde beglazing

isolerende dubbele beglazing

afmetingen profielen volgens opgave fabrikant/leverancier

vliesgevel

ROTHUIZEN

ARCHITECTEN STEDENBOUWKUNDIGEN



BOUWMEESTERPRO

project: JRCZ Middelburg	datum: 17-12-2020	formaat: A3p	getekend: HDC	status: U0
onderdeel: Principedetail N1	schaal: 1 : 10	infoniveau: 300	projectnr: PR19-03	document: U40-N1
contact: www.rothuisen.eu				

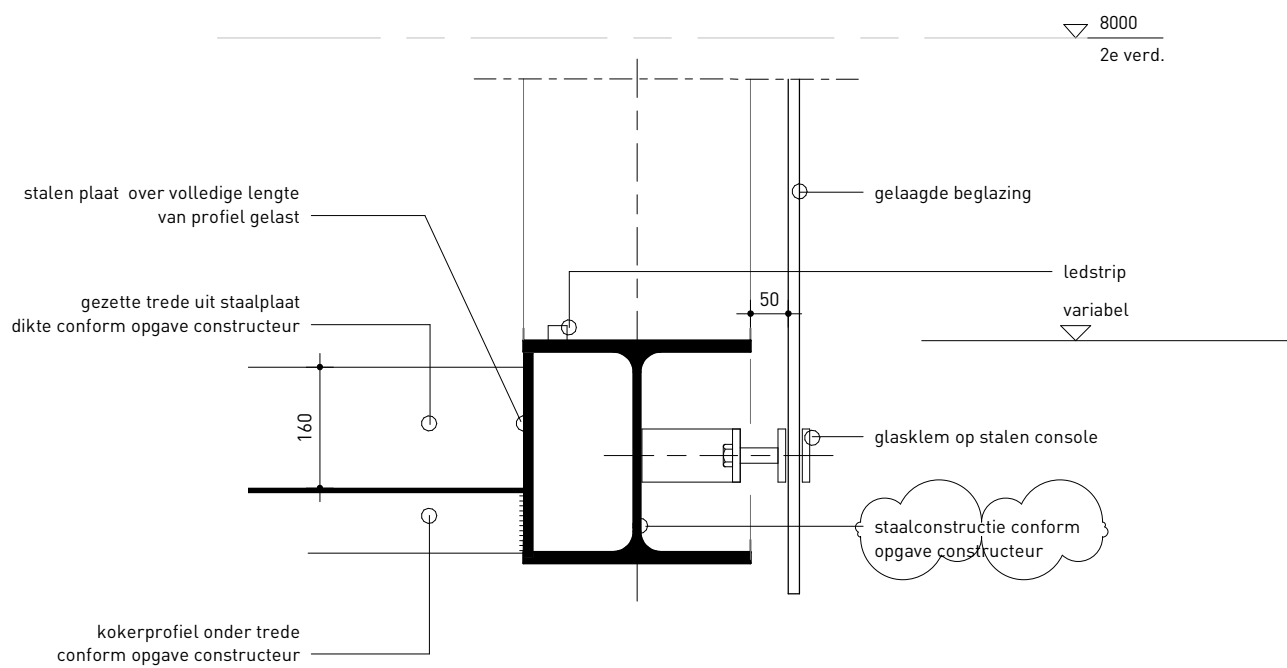
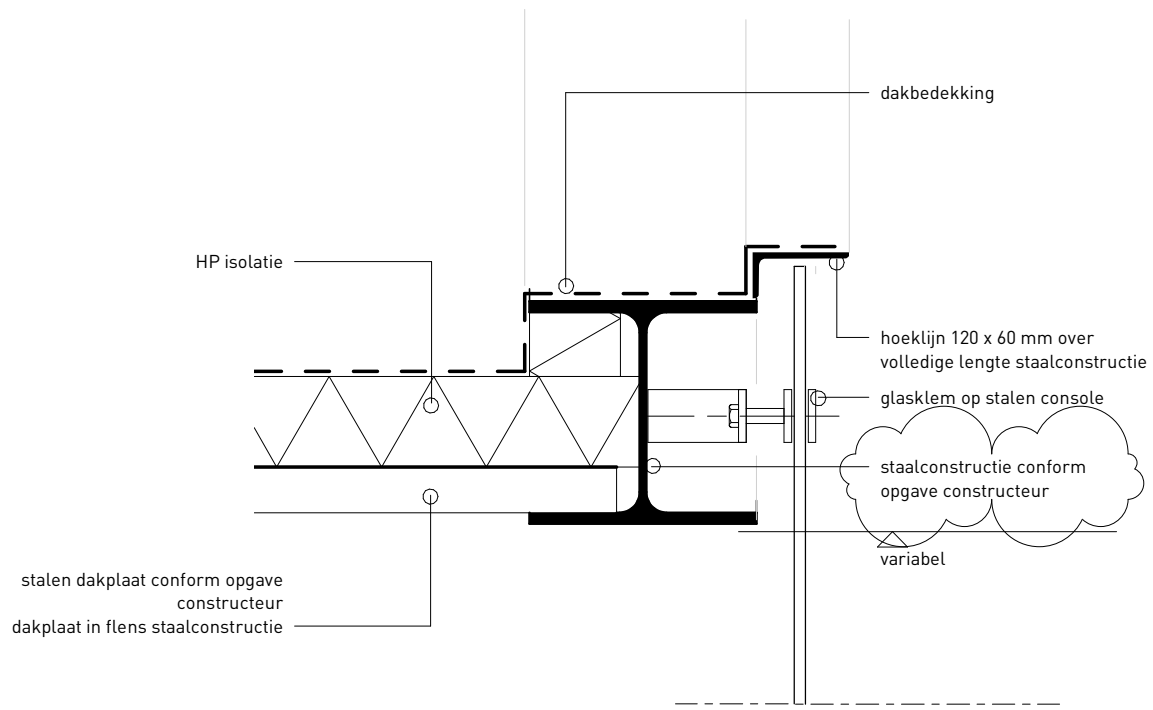

3

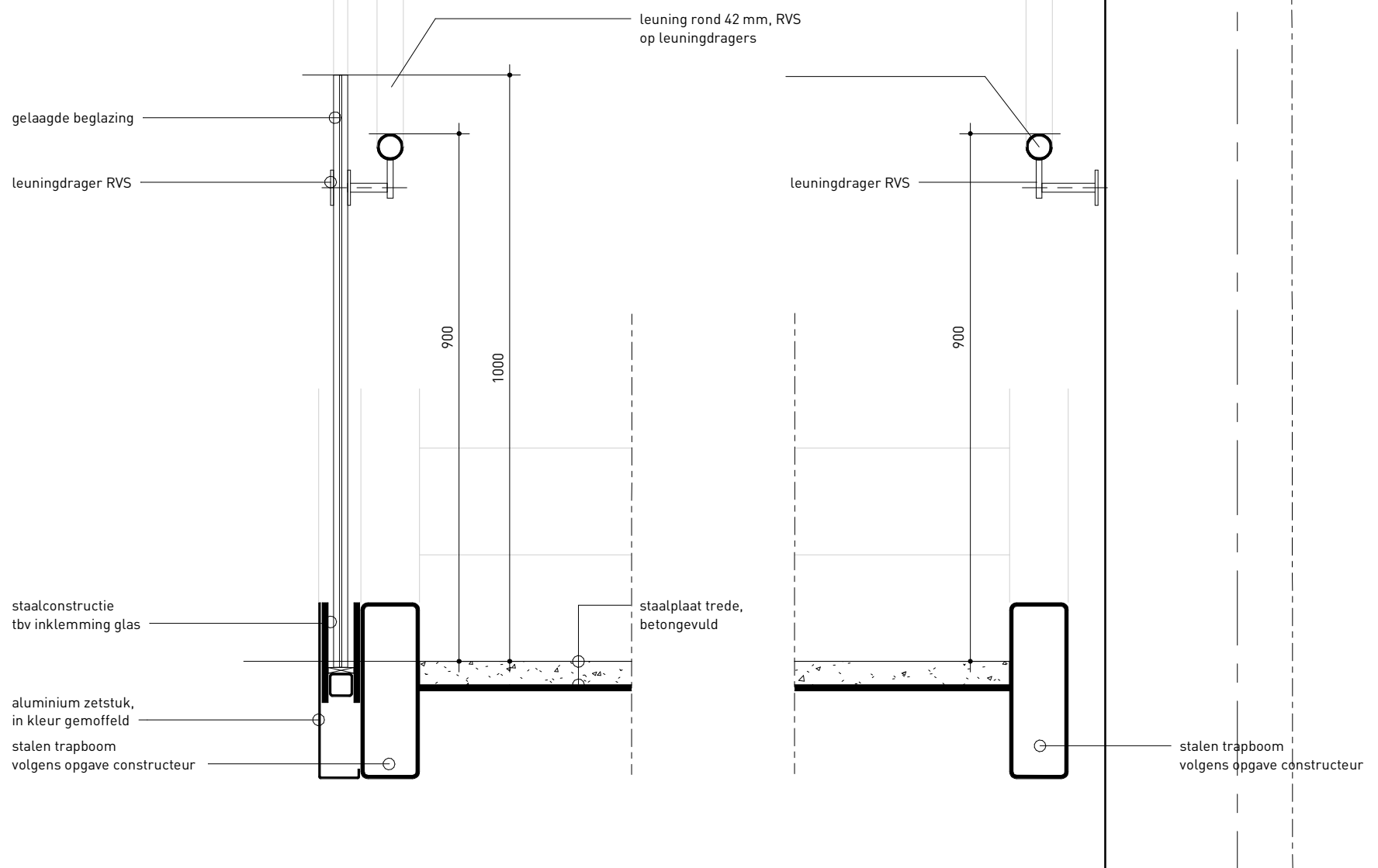

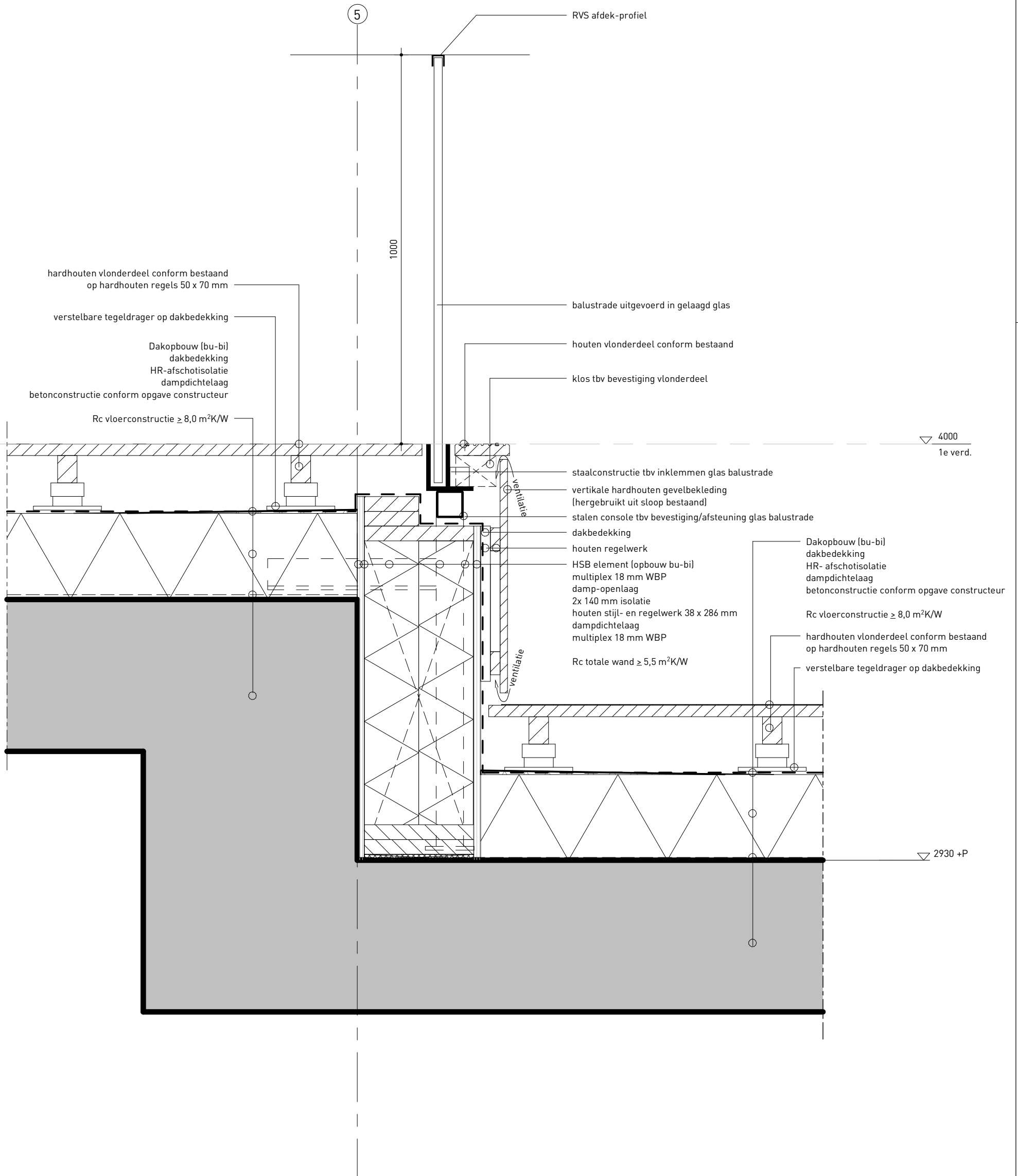

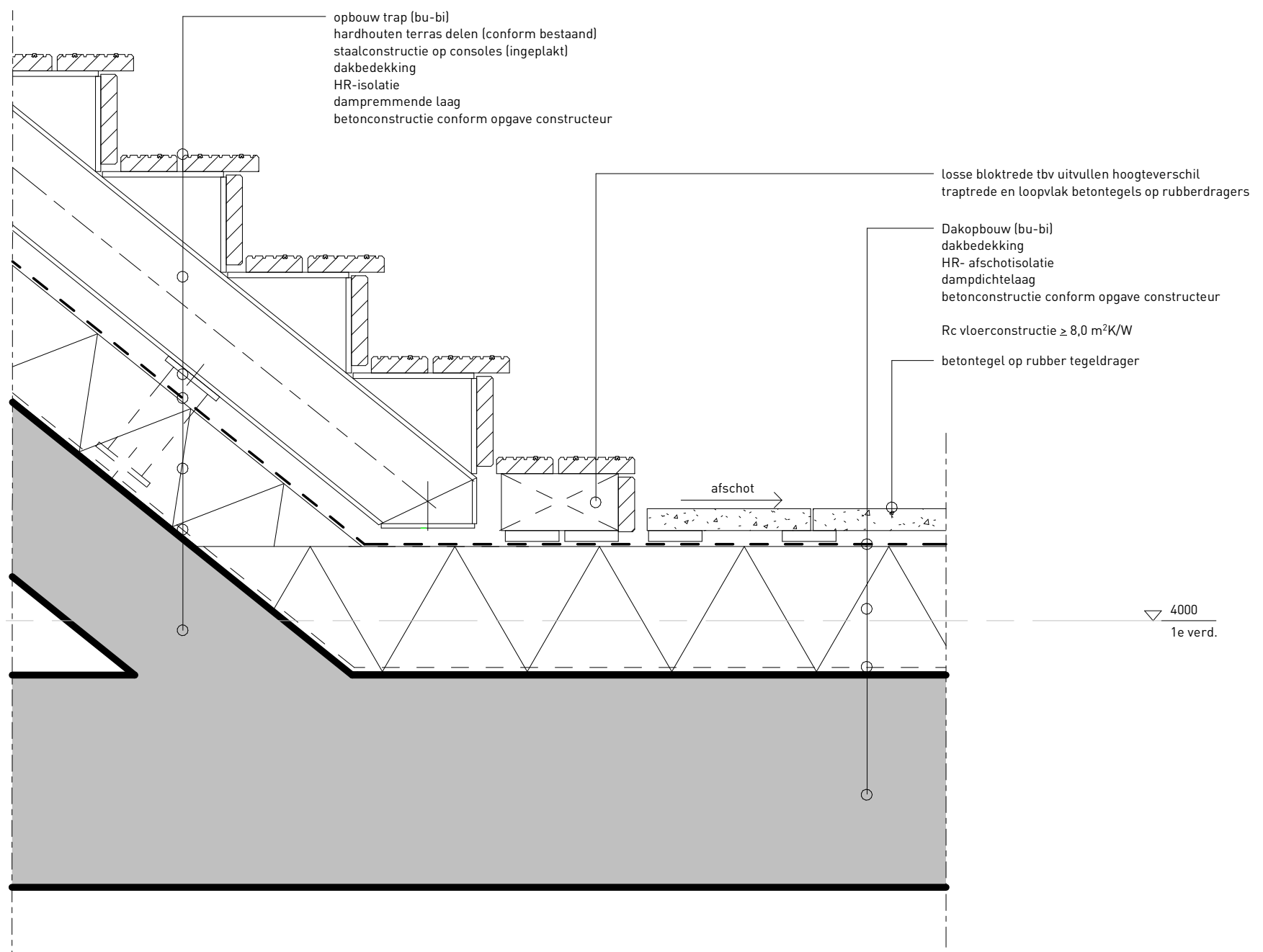

ROTHUIZEN

ARCHITECTEN STEDENBOUWKUNDIGEN



BOUWMEESTERPRO

project: **JRCZ Middelburg** datum: 17-12-2020 formaat: A3p getekend: HDC status: U0
 onderdeel: **Principedetail R3** schaal: 1:10 infoniveau: 300 projectnr: PR19-03 document: U40-R3
 contact: www.rothuisen.eu

geïsoleerd houten HSB-rekje tbv waterkering bordes

Dakopbouw (bu-bi)
dakbedekking
HR- afschotisolatie
dampdichtelaag
betonconstructie conform opgave constructeur

Rc vloerconstructie $\geq 8,0 \text{ m}^2\text{K/W}$

hardhouten vlonderdeel conform bestaand
op hardhouten regels 50 x 70 mm
verstelbare tegeldrager op dakbedekking

opbouw trap (bu-bi)
hardhouten terras delen (conform bestaand)
staalconstructie op consoles (ingeplakt)
dakbedekking
HR-isolatie
dampremmende laag
betonconstructie conform opgave constructeur

Rc vloerconstructie $\geq 8,0 \text{ m}^2\text{K/W}$

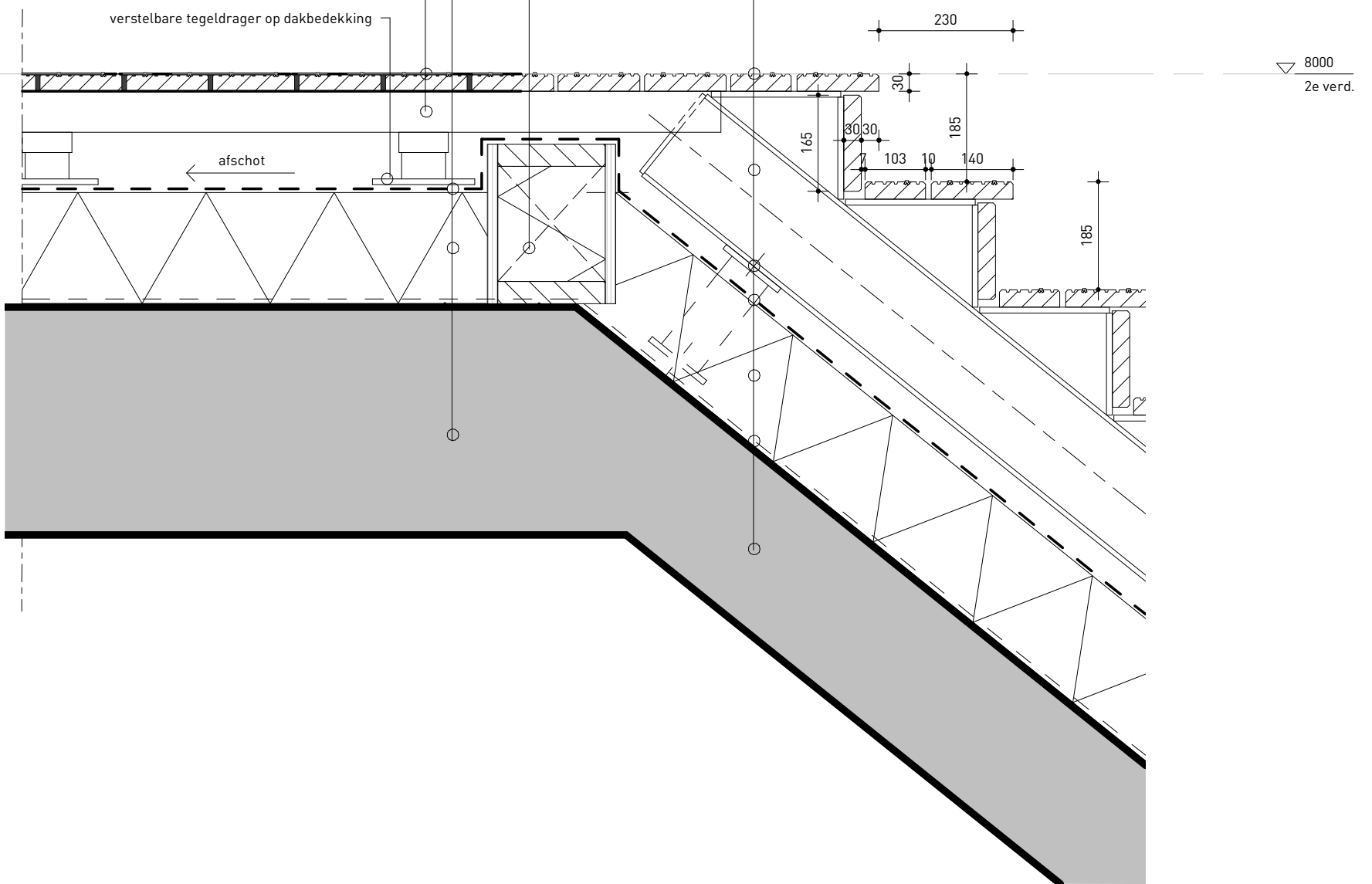

ROTHUIZEN

ARCHITECTEN STEDENBOUWKUNDIGEN



BOUWMEESTERPRO

project: **JRCZ Middelburg**
onderdeel: **Principedetail R4**

contact: www.rothuisen.eu

datum: 17-12-2020

formaat: A3p

getekend: HDC

status: U0

schaal: 1:10

infoniveau: 300

projectnr: PR19-03

document: U40-R4

5

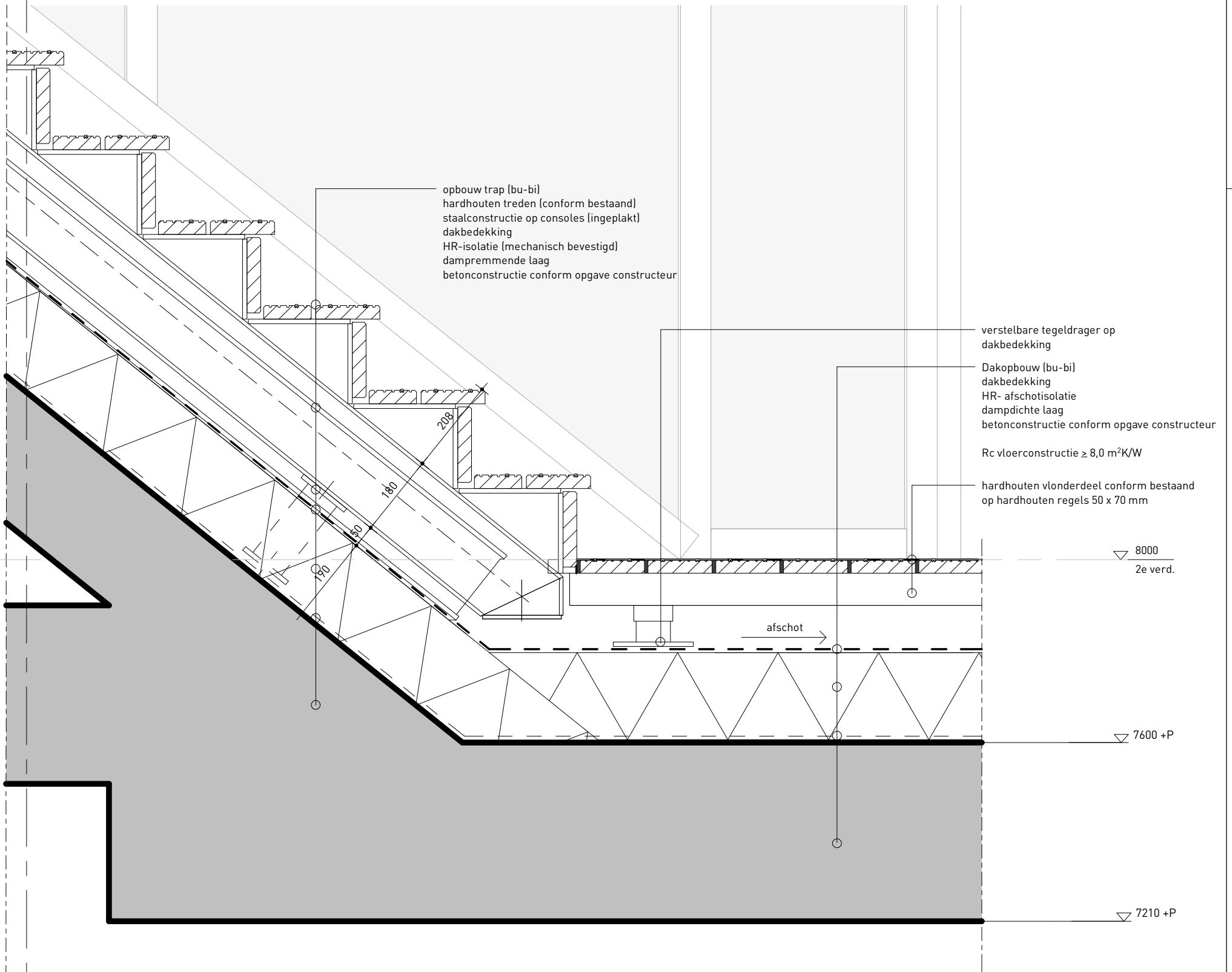

opbouw trap (bu-bi)
hardhouten treden (conform bestaand)
staalconstructie op consoles (ingeplakt)
dakbedekking
HR-isolatie (mechanisch bevestigd)
dampremmende laag
betonconstructie conform opgave constructeur

verstelbare tegeldrager op
dakbedekking
Dakopbouw (bu-bi)
dakbedekking
HR- afschotisolatie
dampdichte laag
betonconstructie conform opgave constructeur
Rc vloerconstructie $\geq 8,0 \text{ m}^2\text{K/W}$
hardhouten vlonderdeel conform bestaand
op hardhouten regels 50 x 70 mm

▽ 8000
2e verd.

▽ 7600 +P

▽ 7210 +P



project:	JRCZ Middelburg	datum:	17-12-2020	formaat:	A3p	getekend:	HDC	status:	U0
onderdeel:	Principedetail R5	schaal:	1:10	infoniveau:	300	projectnr:	PR19-03	document:	U40-R5
contact:	www.rothuizen.eu								